

MODEL 49104-1



# T-MAXX

**TRAXXAS**

OWNER'S MANUAL

# INTRODUCTION

- 3 BEFORE YOU PROCEED
- 4 SAFETY PRECAUTIONS
- 5 TOOLS, SUPPLIES, AND REQUIRED EQUIPMENT
- 6 ANATOMY OF THE T-MAXX
- 7 QUICK START: GETTING UP TO SPEED
- 8 TRAXXAS TQ 2.4GHZ RADIO SYSTEM
- 14 THE TRX 2.5 RACING ENGINE
- 29 DRIVING YOUR T-MAXX
- 30 TUNING ADJUSTMENTS
- 33 MAINTAINING AND STORING YOUR T-MAXX
- 35 TROUBLESHOOTING YOUR T-MAXX

Thank you for purchasing a Traxxas T-Maxx Nitro Monster Truck. Traxxas engineers have loaded your T-Maxx with innovative features and incredible “drive-over-anything” performance that you won’t find anywhere else!

Your T-Maxx combines automatic, two-speed shifting in forward and reverse, with powerful four-wheel disc braking. The patented transmission design and TQ 2.4GHz system put these functions right at your fingertips.

The TRX 2.5 engine is one of the most powerful engines of its size ever available in a Ready-To-Race® truck. Two years of engineering development and advanced design, along with thousands of hours of testing, puts the TRX 2.5 in a class by itself. Each part of the TRX 2.5, from the air filter on the slide carburetor, to the tip on the dyno-tuned exhaust system, has been carefully engineered to provide maximum power over the broadest RPM range.

We know you’re excited about getting your new T-Maxx on the road, but it’s very important that you take some time to read through the Owner’s Manual. This manual contains all the necessary set-up, break-in, tuning, and operating procedures that allow you to unlock the incredible performance and adjustment potential that Traxxas engineers designed into T-Maxx. **Even if you are an experienced R/C enthusiast, it’s important to read and follow the procedures in this manual. Pay particular attention to the fuel and break-in requirements for the engine. The advanced design of the TRX Racing Engine has a special break-in procedure that has been developed and proven to produce the best-performing engine possible. Using traditional or old-fashioned procedures could reduce engine performance and longevity.**

#### FCC Compliance

This device contains a module that complies with the limits for a Class B digital device as described in part 15 of the FCC rules. Operation is subject to the following two conditions: (1) This device may not cause harmful interference, and (2) this device must accept any interference received, including interference that may cause undesired operation.

The limits for a Class B digital device are designed to provide reasonable protection against harmful interference in residential settings. This product generates, uses and can radiate radio frequency energy, and, if not operated in accordance with the instructions, may cause harmful interference to radio communications. The user is cautioned that changes or modifications not expressly approved by the party responsible for compliance could void the user’s authority to operate the equipment.

#### Canada, Industry Canada (IC)

This Class B digital apparatus complies with Canadian ICES-003 and RSS-210. This device complies with Industry Canada license exempt RSS standard(s). Operation is subject to the following two conditions: This device may not cause interference, and This device must accept any interference, including interference that may cause undesired operation of the device.

#### Radio Frequency (RF) Exposure Statement

This equipment complies with radio frequency exposure limits set forth by FCC and Industry Canada for an uncontrolled environment. This equipment should be installed and operated with a minimum distance of 20 centimeters between the radiator and your body or bystanders and must not be co-located or operated in conjunction with any other antenna or transmitter.

Operation Frequency: 2406–2453 MHz

Maximum Radio Frequency Power: Maximum Peak Power -1 dBm

### Traxxas Support

Traxxas support is with you every step of the way. Refer to the next page to find out how to contact us and what your support options are.



### Quick Start

This manual is designed with a Quick Start path that outlines the necessary procedures to get your model up and running in the shortest time possible. If you are an experienced R/C enthusiast, you will find it helpful and fast. Be sure and read through the rest of the manual to learn about important safety, maintenance, and adjustment procedures. Turn to page 7 to begin.



T-Maxx is made to be a complete package that starts with the highest level of engineering and is equipped stock with one of the most powerful Ready-To-Race® engines available. We want you to feel confident that you own the best-performing truck in the market and that it is backed by a team of professionals who aim to provide the highest level of factory support possible. T-Maxx is about experiencing total performance and satisfaction, not just with your truck, but also with the company that stands behind it.

Thank you again for going with Traxxas. We work hard every day to ensure you receive the highest level of customer satisfaction possible. We truly want you to enjoy your new T-Maxx!

## BEFORE YOU PROCEED

Carefully read and follow all instructions in this and any accompanying materials to prevent serious damage to your model. Failure to follow these instructions will be considered abuse and/or neglect.

Before running your model, look over this entire manual and examine the truck carefully. If for some reason you decide the T-Maxx is not what you wanted, then do not continue any further. Your hobby dealer absolutely cannot accept a T-Maxx for return or exchange after it has been run.

### WARNINGS, HELPFUL HINTS, & CROSS-REFERENCES

Throughout this manual, you'll notice warnings and helpful hints identified by the icons below. Be sure to read them!



An important warning about personal safety or avoiding damage to your model and related components.



Special advice from Traxxas to make things easier and more fun.



Refers you to a page with a related topic.

### SUPPORT

If you have any questions about your model or its operation, call the Traxxas Technical Support line toll-free at: **1-888-TRAXXAS (1-888-872-9927)\***

Technical support is available 7 days a week from 8:30am to 9:00pm central time. Technical assistance is also available at [Traxxas.com](http://Traxxas.com). You may also e-mail customer support with your question at **support@Traxxas.com**. Join thousands of registered members in our online community at [Traxxas.com](http://Traxxas.com).

Traxxas offers a full-service, on-site repair facility to handle any of your Traxxas service needs. Maintenance and replacement parts may be purchased directly from Traxxas by phone or online at [Traxxas.com](http://Traxxas.com). You can save time, along with shipping and handling costs, by purchasing replacement parts from your local dealer.

Do not hesitate to contact us with any of your product support needs. We want you to be thoroughly satisfied with your new model!

### REGISTERING YOUR MODEL

In order to serve you better as our customer, please register your product within 10 days of your purchase online at [Traxxas.com/register](http://Traxxas.com/register).

[Traxxas.com/register](http://Traxxas.com/register)

### Traxxas

6250 Traxxas Way  
McKinney, TX 75070  
Phone: 972-549-3000  
Toll-free 1-888-TRAXXAS

### Internet

[Traxxas.com](http://Traxxas.com)  
E-mail: [support@Traxxas.com](mailto:support@Traxxas.com)

Entire contents ©2023 Traxxas. Traxxas, Maxx, T-Maxx, TRX 2.5 Racing Engine, TQ, Top Fuel, EZ-Start, Ready-To-Race, Ready-To-Win, and ProGraphix are trademarks or registered trademarks of Traxxas. Other brand names and marks are the property of their respective holders and are used only for purposes of identification. No part of this manual may be reproduced or distributed in print or electronic media without the express written permission of Traxxas. Specifications are subject to change without notice.



## SAFETY PRECAUTIONS



All instructions and precautions outlined in this manual should be strictly followed to ensure safe operation of your model.



This model is not intended for use by children (minors) under 16 years of age without the supervision of a responsible and knowledgeable adult.



Previous experience with radio controlled models is mandatory. These models are capable of high speeds, requiring experienced driving control. Models require detailed setup, and/or maintenance procedures with required support equipment.



All of us at Traxxas want you to safely enjoy your new T-Maxx. Operate your T-Maxx sensibly and with care, and it will be exciting, safe, and fun for you and those around you. Failure to operate your T-Maxx in a safe and responsible manner may result in property damage and serious injury. The precautions outlined in this manual should be strictly followed to help ensure safe operation. You alone must see that the instructions are followed and the precautions are adhered to.

### IMPORTANT POINTS TO REMEMBER

- T-Maxx is very fast! The T-Maxx is intended for experienced users with a high level of skill. The TRX 2.5 Racing Engine is extremely powerful and may require skilled driving to maintain control. Children under 16 years of age and inexperienced drivers should not operate the T-Maxx without the supervision of a responsible and knowledgeable (experienced) adult.
- **Model engine fuel is dangerous and highly poisonous.** Always follow all directions and precautions printed on the fuel container. Model engine fuel is poisonous to humans and animals. Drinking the fuel can cause blindness and death. Handle with care and respect.
- Model engine fuel, especially when in a fuel dispensing bottle, may look like a cool drink to a child. **Keep all fuel out of the reach of children at all times. Do not place fuel containers on the ground where children can reach them while you are driving.**
- Model engine fuel is flammable. Never allow smoking, sparks, heat, or flame in the presence of fuel or fuel vapors.
- The engine, brakes, and exhaust system may become extremely hot during use. Be careful not to touch these parts, especially when refueling or stopping the engine.
- Prolonged exposure to the engine exhaust can be harmful. Avoid breathing the engine exhaust. Always run your T-Maxx outdoors, in a well-ventilated area. Never run the engine indoors.
- Do not operate your T-Maxx at night, or anytime your line of sight to the model may be obstructed or impaired in any way.
- Never operate your T-Maxx in crowds of people or busy pedestrian areas. T-Maxx is very fast and could cause injury to those unaware of its presence. Keep small children at a safe distance away from the operating area.
- Because T-Maxx is controlled by radio, it is subject to radio interference from many sources beyond your control. Since radio interference can cause momentary loss of control, always allow a safety margin in all directions around your model to prevent collisions.
- The engine can be loud. If the noise makes you uncomfortable, wear ear protection. Be considerate of your neighbors by not running your model early in the morning or late in the evening.
- Do not cut the antenna "stinger" or any other part of the antenna wire. Cutting the antenna will reduce range.
- Do not kink the antenna wire. Kinks in the antenna wire will reduce range.
- You must extend the antenna wire in the model as far as possible for maximum range. In doing so, the antenna wire will be extended outside of the vehicle body. Do not wrap or coil the antenna wire to keep it from extending out of the body.
- Do not allow the antenna wire to extend outside the body without the protection of an antenna tube, or the antenna wire may incur crash damage that could reduce range.
- **Most importantly, use good common sense at all times.**

### BATTERIES AND BATTERY CHARGING

Your model uses rechargeable batteries that must be handled with care for safety and long battery life. Make sure to read and follow all instructions and precautions that were provided with the battery packs and your charger. It is your responsibility to charge and care for the battery packs properly. In addition to your battery and charger instructions, here are some more tips to keep in mind.

- Use the supplied charger to charge the included battery. See "Charging the EZ-Start Battery" on page 21.
- Do not charge batteries inside of an automobile. Do not charge batteries while driving in an automobile. The charger is equipped with a long cord intended to allow the battery to be charged outside of an automobile when using the automobile's auxiliary power socket. If the cord will not reach outside of the automobile, find another power source.
- Never leave batteries to charge unattended.
- Allow the battery pack to cool off before charging.
- Do not use battery packs that have been damaged in any way. Do not use battery packs that have damaged wiring, exposed wiring, or a damaged connector as this may create the risk of fire.
- Children should have responsible adult supervision when charging and handling batteries.
- Never charge batteries on wood, cloth, carpet or on any other flammable material.
- Do not operate the charger in a cluttered space, or place objects on top of the charger or battery.
- If a battery gets hot to the touch during the charging process (temperature greater than 140°F / 60°C), disconnect the battery from the charger and discontinue charging immediately.
- Always store battery packs safely out of the reach of children and pets.
- Do not expose the charger to water or moisture.
- Do not disassemble the charger.
- Only use approved chargers for Nickel Metal Hydride (NiMH) battery packs. Do not exceed the maximum charge rate of 1 amp.
- Do not short-circuit the battery pack. This may cause burns and severe damage to the battery pack.
- Do not burn or puncture the batteries. Toxic materials could be released. If eye or skin contact occurs, flush with water.
- Store the battery pack in a dry location, away from heat sources and direct sunlight.
- NiMH batteries must be recycled or disposed of properly.

### Recycling Your Traxxas Power Cell NiMH Battery

Traxxas strongly encourages you to recycle your Power Cell NiMH battery when it has reached the end of its useful life. **Do not throw your battery in the trash.** All Power Cell NiMH battery packs display the RBRC (Rechargeable Battery Recycling Corporation) icon, indicating they are recyclable. To find a recycling center near you, ask your local hobby dealer or visit [www.call2recycle.org](http://www.call2recycle.org).

# TOOLS, SUPPLIES, AND REQUIRED EQUIPMENT

T-Maxx comes with a set of specialty metric tools. You'll need to purchase other items, available from your hobby dealer, to operate and maintain your model.

## SUPPLIED TOOLS AND EQUIPMENT



Turnbuckle wrenches



U-joint wrench



4-way wrench

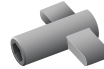

Antenna nut wrench



Extra glow plug



Glow plug and wheel nut wrench



1.5mm "L" wrench



2.0mm "L" wrench



2.5mm "L" wrench



5.0mm "L" wrench



Foam air filter oil and extra oiled air filter element

(see page 19)



NiMH 7.2V battery pack\*



NiMH 7.2V battery charger\*



Fuel dispensing bottle

## REQUIRED TOOLS AND EQUIPMENT (SOLD SEPARATELY)



20% quart - #5020  
33% quart - #5030  
20% gallon - #5070  
33% gallon - #5080

Traxxas Top Fuel™  
see page 18



8 AA alkaline batteries



After-run oil to protect the engine from corrosion



Small flat-blade screwdriver for tuning (1/8 inch blade)



For more information on radio system batteries, see *Use the Right Batteries* on page 10.



**Recommended Equipment**  
These items are not required for the operation of your model, but are a good idea to include in any R/C toolbox:

- Safety glasses
- Traxxas Ultra Premium Tire Glue, part #6468 (CA glue)
- Hobby knife
- Side cutters and/or needle nose pliers
- Philips screwdriver
- Soldering iron

\*Battery and charger style are subject to change and may vary from images.

# ANATOMY OF THE T-MAXX

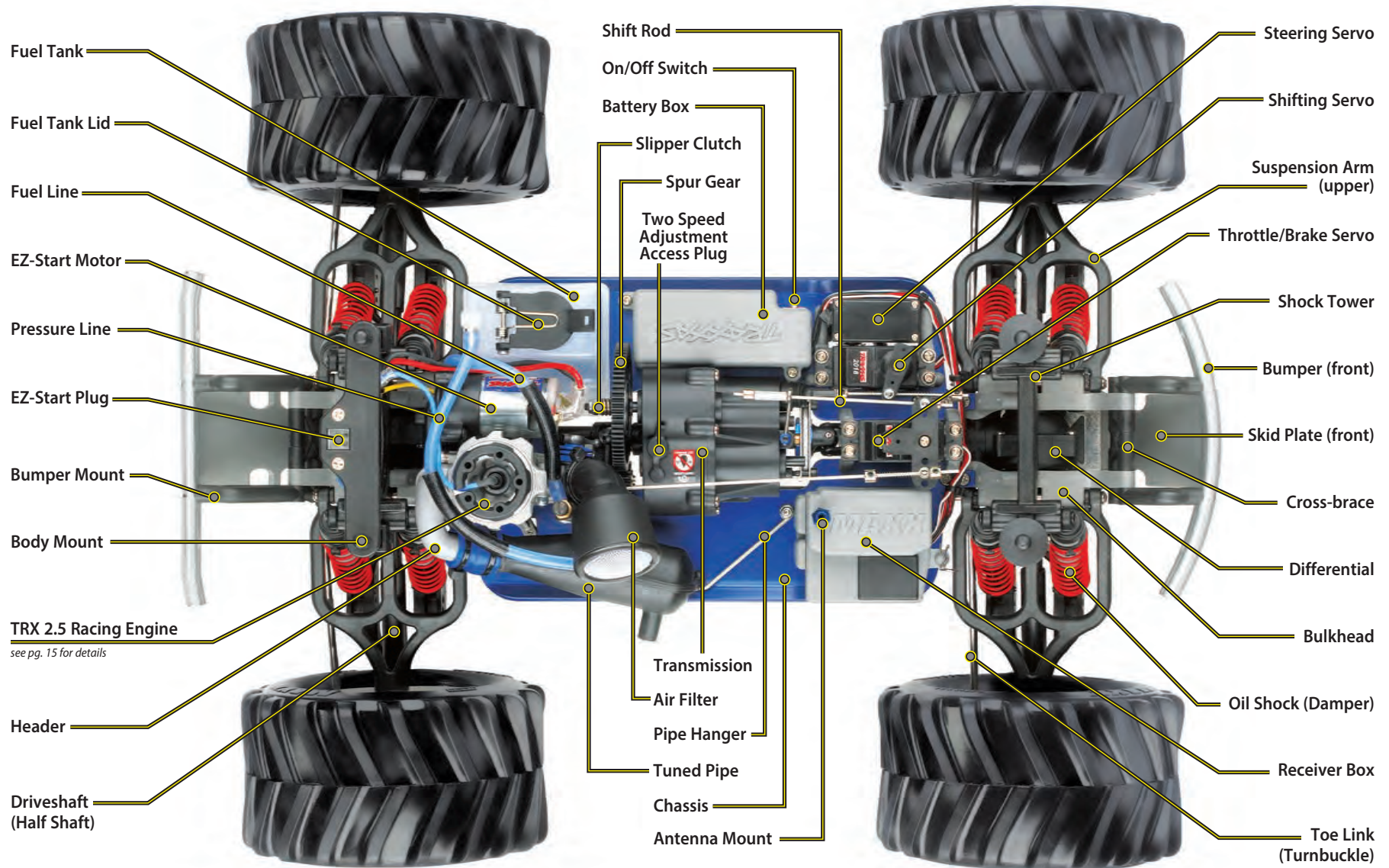

## QUICK START: GETTING UP TO SPEED

 The following guide is an overview of the procedures for getting your T-Maxx running, from opening the box to breaking in and tuning your engine. Refer to the pages indicated for details on each step. Look for the Quick Start logo on the bottom corners of Quick Start pages.

**1. Read the safety precautions on page 4**

For your own safety, understand where carelessness and misuse could lead to personal injury.

**10. Range test the radio system • See page 12**

Follow this procedure to make sure your radio system works properly at a distance and that there is no interference from outside sources.

**2. Charge the EZ-Start battery pack • See page 22**

The EZ-Start requires a fully charged 7.2-volt battery pack (included).

**11. Fill the fuel tank • See page 19**

Use your fuel-dispensing bottle to fill the tank.

**3. Install the antenna • See page 10**

The receiver antenna and antenna tube must be properly installed before operating your model.

**12. Connect the EZ-Start to the model • See page 22**

Learn the proper way to use the EZ-Start electric starting system.

**4. Install batteries in the transmitter • See page 10**

T-Maxx requires 4 AA alkaline or rechargeable batteries\* for the transmitter.

**13. Start the engine • See page 24**

Learn to use the correct starting procedure for your TRX 2.5.

**5. Decal and Install the body • See page 8**

You will need to use the body during break in, so it's best to apply any additional decals before you use the body.

**14. Break-in your engine • See page 24**

Follow the break-in instructions exactly to ensure the best-performing, longest-lasting engine.

**6. Install the receiver batteries • See page 10**

T-Maxx requires 4 AA alkaline or rechargeable batteries\* for the receiver.

**15. Tune your engine • See page 26**

Learn how to set the fuel mixture needles for optimum engine performance.

**7. Install the EZ-Start battery • See page 22**

Install and connect a charged 7.2-volt battery pack in the EZ-Start controller.

**16. Drive your T-Maxx • See page 29**

Learn to use the two-speed and reverse functions on your truck, along with important driving precautions.

**8. Turn on the radio system • See page 11**

Make a habit of turning the transmitter on first and off last.

**17. Maintain your Truck • See pages 33-34**

Follow these critical steps to maintain the performance of your T-Maxx and keep it in excellent running condition.

**9. Check servo operation • See page 12**

Make sure the throttle, shifting, and steering servos are working correctly.



The Quick Start Guide is not intended to replace the full operating instructions available in this manual. Please read this entire manual for complete instructions on the proper use and maintenance of your T-Maxx.



Look for the Quick Start logo at the bottom of Quick Start pages.

\*sold separately



# TRAXXAS TQ 2.4GHZ RADIO SYSTEM



## Applying The Decals

The main decals for your model have been applied at the factory. Additional decals are printed on self-adhesive clear mylar and are die-cut for easy removal. Use a hobby knife to lift the corner of a decal and lift it from the backing.

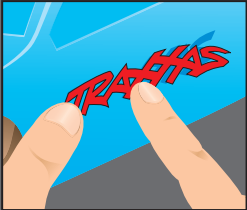
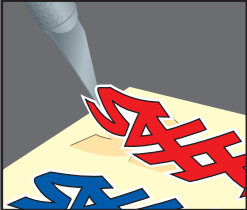

To apply the decals, place one end down, hold the other end up, and gradually smooth the decal down with your finger as you go. This will prevent air bubbles. Placing both ends of the decal down and then trying to smooth it out will result in air pockets.

Your model is equipped with the Traxxas TQ 2.4GHz transmitter. The transmitter has three channels: Channel one operates the steering, channel two operates the throttle, and channel three operates shifting. The receiver inside the model has three output channels. Your model is equipped with three servos and a receiver.

## TQ 2.4GHZ TRANSMITTER



## WIRING DIAGRAM

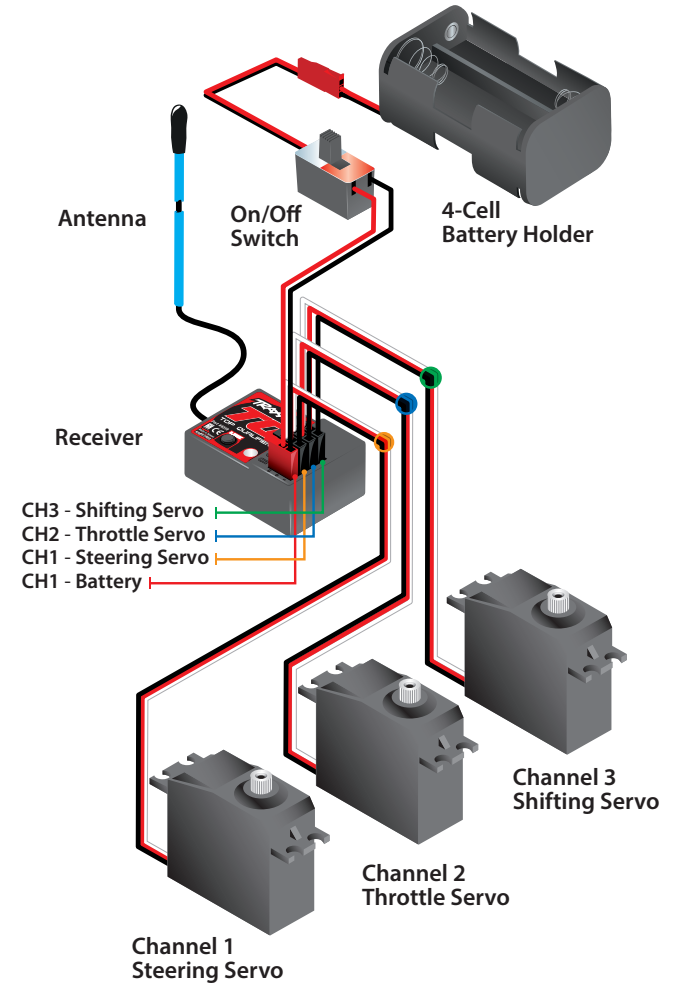



## INTRODUCTION

Your model includes the TQ 2.4GHz transmitter. When powered on, the TQ will automatically locate and lock onto an available frequency, allowing multiple models to be raced together without frequency conflicts. Just switch on and drive! The included TQ 2.4GHz radio system has been programmed for your model at the factory and does not require adjustment, but it does have settings you may need to access to maintain proper operation of your model. The detailed instructions (page 11) included in this manual will help you understand and operate the functions of the new TQ 2.4GHz radio system. For additional information and how-to videos, visit [Traxxas.com](http://Traxxas.com).

## RADIO SYSTEM TERMINOLOGY

Please take a moment to familiarize yourself with these radio and power system terms. They will be used throughout this manual.

**2.4GHz Spread Spectrum** – This model is equipped with the latest R/C technology. Unlike AM and FM systems that require frequency crystals and are prone to frequency conflicts, the TQ 2.4GHz system automatically selects and locks onto an open frequency, and offers superior resistance to interference and “glitching.”

**Current** – Current is a measure of power flow through the electronics, usually measured in amps. If you think of a wire as a garden hose, current is a measure of how much water is flowing through the hose.

**Frequency band** – The radio frequency used by the transmitter to send signals to your model. This model operates on the 2.4GHz direct-sequence spread spectrum.

**mAh** – Abbreviation for milliamp hour, a measure of the capacity of the battery pack. The higher the number, the longer the battery will last between recharges.

**Neutral position** – The standing position that the servos seek when the transmitter controls are at the neutral setting.

**NiCad** – Abbreviation for nickel-cadmium. The original rechargeable hobby pack, NiCad batteries have very high current handling, high capacity, and can last up to 1000 charging cycles. Good charging procedures are required to reduce the possibility of developing a “memory” effect and shortened run times.

**NiMH** – Abbreviation for nickel-metal hydride. Rechargeable NiMH batteries offer high-current handling and much greater resistance to the “memory” effect. NiMH batteries generally allow higher capacity than NiCad batteries. They can last up to 500 charge cycles. A peak charger designed for NiMH batteries is required for optimal performance.

**Receiver** – The radio unit inside your model that receives signals from the transmitter and relays them to the servos.

**Servos** – Small motor units in your model that operate the steering and throttle mechanisms.

**Transmitter** – The hand-held radio unit that sends throttle and steering instructions to your model.

**Trim** – The fine-tuning adjustment of the neutral position of the servos, made by adjusting the steering trim knob on the face of the transmitter.

**2-channel radio system** – The TQ radio system, consisting of the receiver, the transmitter, and the servos. The system uses two channels: one to operate the throttle and one to operate the steering.

## RADIO SYSTEM PRECAUTIONS

- Do not kink the receiver antenna wire. Kinks in the antenna wire will reduce range.
- DO NOT CUT any part of the receiver antenna wire. Cutting the antenna will reduce range.
- Extend the antenna wire in the model as far as possible for maximum range. In doing so, the antenna wire will be extended outside of the vehicle body. Do not wrap or coil the antenna wire to keep it from extending out of the body.
- The antenna wire must be installed into the antenna tube to protect it from getting cut or damaged, which will reduce range. When installing the antenna wire into the antenna tube, be careful not to kink the wire by pressing it against the antenna tube cap. The antenna wire should extend to just below or to within one-half inch below the cap.



Learn terms related to the TRX 2.5 Racing Engine beginning on page 16.



To prevent loss of radio range, do not kink or cut the black wire, do not bend or cut the metal tip, and do not bend or cut the white wire at the end of the metal tip.

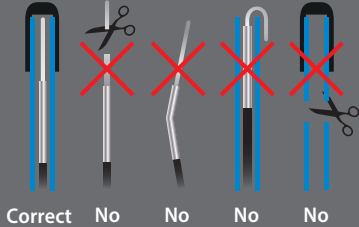

### Use the Right Batteries

Your transmitter uses AA batteries. Use new alkaline batteries or rechargeable batteries in your transmitter. Make sure rechargeable batteries are fully charged according to the manufacturer's instructions.

If you use rechargeable batteries in your transmitter, be aware that when they begin to lose their charge, they lose power more quickly than regular alkaline batteries.

Caution: Discontinue running your model at the first sign of weak batteries (flashing red LED) to avoid losing control.



## INSTALLING THE RECEIVER ANTENNA

The receiver antenna and antenna tube must be properly installed before operating your model. The antenna tube has been precisely cut to match the length of the antenna wire. Follow these steps to install the antenna and antenna tube:

1. Slide the antenna wire into the antenna tube until the antenna's white tip just reaches the tube cap. Do not crush the antenna wire against the cap.
2. Insert the tube into the antenna post. Take care not to crimp the antenna wire.
3. Slide the crimp nut over the antenna tube and thread it onto the antenna post. Use the supplied tool to thread the crimp nut over the post until the antenna tube is secure. Do not over-tighten the nut or crush the antenna wire against the chassis. Do not bend or kink the antenna wire! Do not shorten the antenna tube. See the side bar for more information.

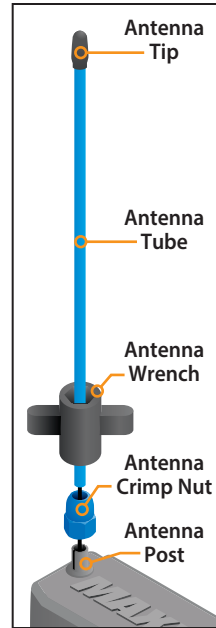

## INSTALLING RECEIVER BATTERIES

The radio receiver in your T-Maxx uses 4 AA batteries. The battery holder for the receiver batteries is located underneath the battery cover. The battery cover can be identified by the on/off switch.

1. Remove the battery cover by removing the two 3x10mm buttonhead cap screws from the cover.
2. Remove the battery holder and install 4 AA alkaline batteries. Make careful note of the battery polarity by comparing against the diagrams in the battery holder.

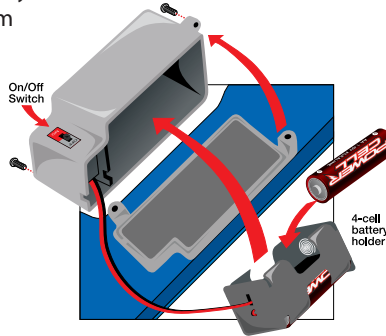

3. Insert the battery holder into the battery cover.

4. Direct the battery wires through the slot in the battery cover. **Note: If the wires are not properly routed, they may become broken or shorted, causing radio system failure and loss of control.**

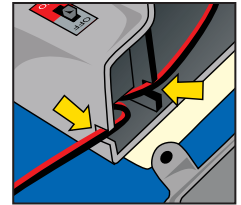

5. Reinstall the battery cover and secure with the screws.

To prevent losing control of your model, it is important to stop at the first sign of weak receiver batteries. Visible warning signals include sluggish steering response and shortened radio range.

## INSTALLING TRANSMITTER BATTERIES

Your TQ 2.4GHz transmitter uses 4 AA batteries. The battery compartment is located in the base of the transmitter.

1. Remove the battery compartment door by pressing the tab and sliding the door open.
2. Install the batteries in the correct orientation as indicated in the battery compartment.
3. Reinstall the battery compartment door and snap it closed.
4. Turn on the transmitter and check the status LED for a solid green light.



If the status LED flashes red, the transmitter batteries may be weak, discharged, or possibly installed incorrectly. Replace with new or freshly charged batteries. The power indicator light does not indicate the charge level of the battery pack installed in the model. Refer to the LED Codes section on page 13 for more information on the transmitter's status LED codes.

## RADIO SYSTEM CONTROLS



## RADIO SYSTEM RULES

- Always turn your TQ 2.4GHz transmitter on first and off last. This procedure will help to prevent your model from receiving stray signals from another transmitter, or other source, and running out of control. Your model has electronic fail-safes to prevent this type of malfunction, but the first, best defense against a runaway model is to always turn the transmitter on first and off last.

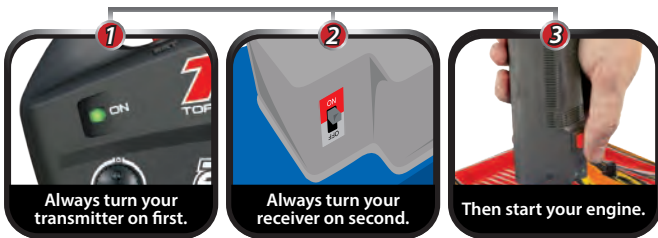

- In order for the transmitter and receiver to bind to one another, the receiver in the model must be turned on within 20 seconds of turning on the transmitter. The transmitter LED will flash fast red, indicating a failure to link. If you miss it, simply turn off the transmitter and start over.

- Always have the transmitter and receiver turned on before you start the engine. Never turn the radio system off while the engine is running. The on/off switch in the model only turns the receiver on and off. It does not turn off the engine.
- Always use new or freshly charged batteries for the radio system. Weak batteries will limit the radio signal between the receiver and the transmitter. Loss of the radio signal can cause you to lose control of your model.

## RADIO SYSTEM BASIC ADJUSTMENTS



### Steering Trim

The steering trim knob located on the face of the transmitter adjusts the neutral (center) point of the steering channel. If your model pulls to the right or left when the steering wheel is centered, turn the knob until the model drives straight when the steering wheel is centered.

### Servo Reversing

The TQ servo direction has been programmed with the correct servo direction settings for your model and should not require adjustment. **These instructions are for reference and troubleshooting only.**

Reversing a channel reverses the direction of the corresponding servo. For example, if you turn the steering wheel to the right and the model turns left, Channel 1 would need to be reversed to correct the servo direction. Use the following procedures to reverse the steering or throttle channel if necessary. **Servo reversing should only be required if you accidentally reset the direction of a channel. Do not reverse the throttle or steering channels unless necessary.**

**Note:** Before performing these procedures, make sure that both the transmitter and receiver are powered on.

### Steering reversing procedure:

1. Press and hold the SET button on the transmitter for two seconds. The status LED will flash green.
2. Turn and hold the steering wheel to the full left or full right position (it does not matter which position you choose).
3. While holding the steering wheel in position, press the SET button to reverse the channel.
4. The channel is now reversed. Confirm correct servo operation before running your model.



Remember to always turn the TQ transmitter on first and off last to avoid loss of control and damage to your model.



If the status LED doesn't light green, check the polarity of the batteries. Check rechargeable batteries for a full charge. If you see any other flashing signal from the status LED, refer to the chart on page 13 to identify the code.



Make certain the model's receiver antenna is properly installed before operating your model. See "Installing the Receiver Antenna." Failure to properly install the receiver antenna will result in greatly reduced radio range and potential loss of control.





Always use the idle speed adjustment screw (see page 21) on the carburetor (see page 15) to adjust the engine idle speed.

#### Throttle reversing procedure:

1. Press and hold the SET button on the transmitter for two seconds. The status LED will flash green.
2. Move and hold the throttle trigger to the full forward or full brake position.
3. While holding the throttle trigger in position, press the SET button to reverse the channel.
4. The channel is now reversed. Confirm correct servo operation before running your model.



**Warning:** Changing the direction of the throttle servo will also change its neutral position. Be certain to confirm the throttle servo properly closes the engine's throttle opening when the transmitter's trigger is at neutral.

#### USING THE RADIO SYSTEM

The TQ 2.4GHz Radio System has been adjusted at the factory for correct operation with your model. The adjustment should be checked before running the model, in case of movement during shipping. Follow these steps:

1. Turn the transmitter switch on. The status LED on the transmitter should be solid green (not flashing).
2. Turn on the receiver switch in the model. The switch is located on the battery compartment.
3. Position T-Maxx so that its front wheels are off the ground.
4. Turn the steering wheel on the transmitter back and forth and check for rapid operation of the steering servo. Also, check that the steering mechanism is not loose or binding. If the steering operates slowly, then make sure you have fresh receiver batteries.
5. When looking down at the model, the front wheels should be pointing straight ahead. If the wheels are turned slightly to the left or right, slowly adjust the steering trim control on the transmitter until they are pointing straight ahead.
6. Operate the throttle trigger on the transmitter and check for rapid operation of the throttle servo. When the throttle trigger is pulled back, the carburetor should open (slide moves out). When the throttle trigger is pushed all the way forward, the brake should lock.

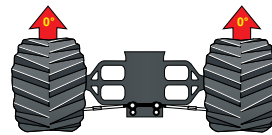

7. Operate the shift button on the transmitter and check for rapid operation of the shifting servo. Push the shift button down for forward. The servo will operate the spring-loaded shift mechanism and you will hear the transmission click into forward. Push the shift button up for reverse and you will again hear the transmission click and shift into gear.
8. Once adjustments are made, turn off the receiver on your T-Maxx, followed by the hand-held transmitter.



The TQ transmitter has a directional antenna. For maximum range, hold the antenna upright and pointed in the direction of the model. Pointing the transmitter away from the model will reduce radio range.



#### Range-Testing the Radio System

Before each running session with your model, you should range-test your radio system to ensure that it operates properly.

1. Turn on the radio system and check its operation as described in the previous section.
2. Have a friend hold the model with the engine off.
3. Walk away from the model with the transmitter until you reach the farthest distance you plan to operate the model.
4. Operate the controls on the transmitter once again to be sure that the model responds correctly.
5. Do not attempt to operate the model if there is any problem with the radio system or any external interference with your radio signal at your location.

#### Higher Speeds Require Greater Distance

The faster you drive your model, the more quickly it will near the limit of radio range. At 50mph, a model can cover 73 feet every second! It's a thrill, but use caution to keep your model in range. If you want to see your model achieve its maximum speed, it is best to position yourself in the middle of its running area, not the



far end, so you drive the model toward and past your position. In addition to maximizing the radio's range, this technique will keep your model closer to you, making it easier to see and control.

**No matter how fast or far you drive your model, always leave adequate space between you, the model, and others. Never drive directly toward yourself or others.**

### TQ 2.4GHz Binding Instructions

For proper operation, the transmitter and receiver must be electronically 'bound.' **This has been done for you at the factory.** Should you ever need to re-bind the system or bind to an additional transmitter or receiver, follow these instructions. Note: the receiver must be connected to a 4.8-6.0v (nominal) power source for binding and the transmitter and receiver must be within 5 feet of each other.

1. Press and hold the SET button on the transmitter.
2. Turn on the transmitter and release the SET button. The status LED will flash red slowly, indicating that the transmitter is in bind mode.
3. Press and hold the LINK button on the receiver.
4. Turn on the vehicle and release the LINK button. The LED on the receiver will flash red, indicating that the receiver is in bind mode.
5. When the LEDs on both the transmitter and the receiver turn solid green, the system is bound and ready for use. Confirm that the steering and throttle operate properly before driving your model.

### TRANSMITTER LED CODES

LED Color / Pattern	Name	Notes
Solid green	Normal Driving Mode	See page 11 for information on how to use the transmitter controls.
Slow red (0.5 sec on / 0.5 sec off)	Binding	See this page for more information on binding.
Flashing medium red (0.25 sec on / 0.25 sec off)	Low Battery Alarm	Put new batteries in the transmitter. See page 10 for more information.
Flashing fast red (0.125 sec on / 0.125 sec off)	Link Failure / Error	Transmitter and receiver are no longer bound. Turn the system off and then back on to resume normal operation. Find source of the link failure (i.e., out of range, low batteries, damaged antenna).

### RECEIVER LED CODES

LED Color / Pattern	Name	Notes
Solid green	Normal Driving Mode	See page 11 for information on how to use your transmitter controls.
Slow red (0.5 sec on / 0.5 sec off)	Binding	See this page for more information on binding.
Flashing fast red (0.125 sec on / 0.125 sec off)	Fail-Safe / Low-Voltage Detect	Consistent low voltage in the receiver triggers Fail-Safe so that there is enough power to center the throttle servo before it completely loses power.



#### Fail-Safe

Your Traxxas radio system is equipped with a built-in Fail-Safe function that returns the throttle to its last saved neutral position in the event of a signal loss. The LED on the transmitter and on the receiver will rapidly flash red when the Fail-Safe mode is activated. If Fail-Safe activates while you are operating your model, determine the reason for signal loss and resolve the problem before operating your model again.

## THE TRX 2.5 RACING ENGINE™



Traxxas strongly discourages changing or modifying any part of the TRX 2.5 Racing Engine. Old tech tips and tricks that may have boosted the power of other engines could seriously diminish the performance of the TRX 2.5 Racing Engine.

There's more advanced thinking, development, and testing in the stock parts of your TRX 2.5 Racing Engine than in many aftermarket manufacturer's performance parts. The TRX 2.5 Racing Engine is already the most powerful engine in its class and may not benefit from average, low-tech, aftermarket bolt-on performance items.

### INTRODUCTION

The TRX 2.5 Racing Engine is a specialty high-performance racing engine. Its impressive performance is the result of years of focused engineering development and thousands of hours of controlled testing and rigorous real-world running. It offers unprecedented power and performance that turns ready-to-run into Ready-To-Race.®

The TRX 2.5 Racing Engine takes a total-system approach. Each part of the engine, from the air filter to the exhaust tip, is carefully engineered to work in harmony with other engine components. Each part complements the next to extract maximum power. The TRX 2.5 Racing Engine is designed to be tolerant of variations in tuning, and to run successfully through a wide range of variable atmospheric conditions such as changes in temperature, humidity, and altitude.

In order to get the longest engine life and keep the TRX 2.5 Racing Engine in top running condition, it is very important to perform regular routine maintenance. **The number one cause of premature engine wear and failure is lack of care and maintenance!**

### BREAK-IN

The TRX 2.5 Racing Engine is manufactured to exacting tolerances and requires a specially-designed break-in procedure to accomplish the final precision fitting of the internal engine components. It is very important that you follow the new break-in procedure as closely as possible to achieve the best performance and longest life from your TRX 2.5 Racing Engine. Engine break-in will take between one and two hours. Old style break-in procedures, such as idling the engine on the bench for several tanks of fuel or simply running the engine with a very rich fuel mixture for the first 4 tanks of fuel, will not achieve the best results. Follow the easy steps in this manual.

### AIR FILTER MAINTENANCE

A clean air filter is critical for long engine life. Due to the high-performance nature of the TRX 2.5 Racing Engine, a tremendous amount of vacuum is created to move a large volume of high-velocity air through the carburetor. Dirt is the worst enemy to your engine. Clean the air filter after each hour of running to prevent sucking dirt into the engine. An extra pre-lubed air filter element has been provided to encourage you to maintain your air filter.



### AFTER-RUN MAINTENANCE

Perform after-run maintenance on the engine to prevent corrosion from building up on the internal engine components. The fuel naturally attracts moisture, and corrosion can build up very quickly inside the engine if it is not prevented.

A few minutes spent before and after each time you run your model will allow you to enjoy it for a long time to come. Read on for more exciting details about your new engine.

TRX 2.5 RACING ENGINE ILLUSTRATED

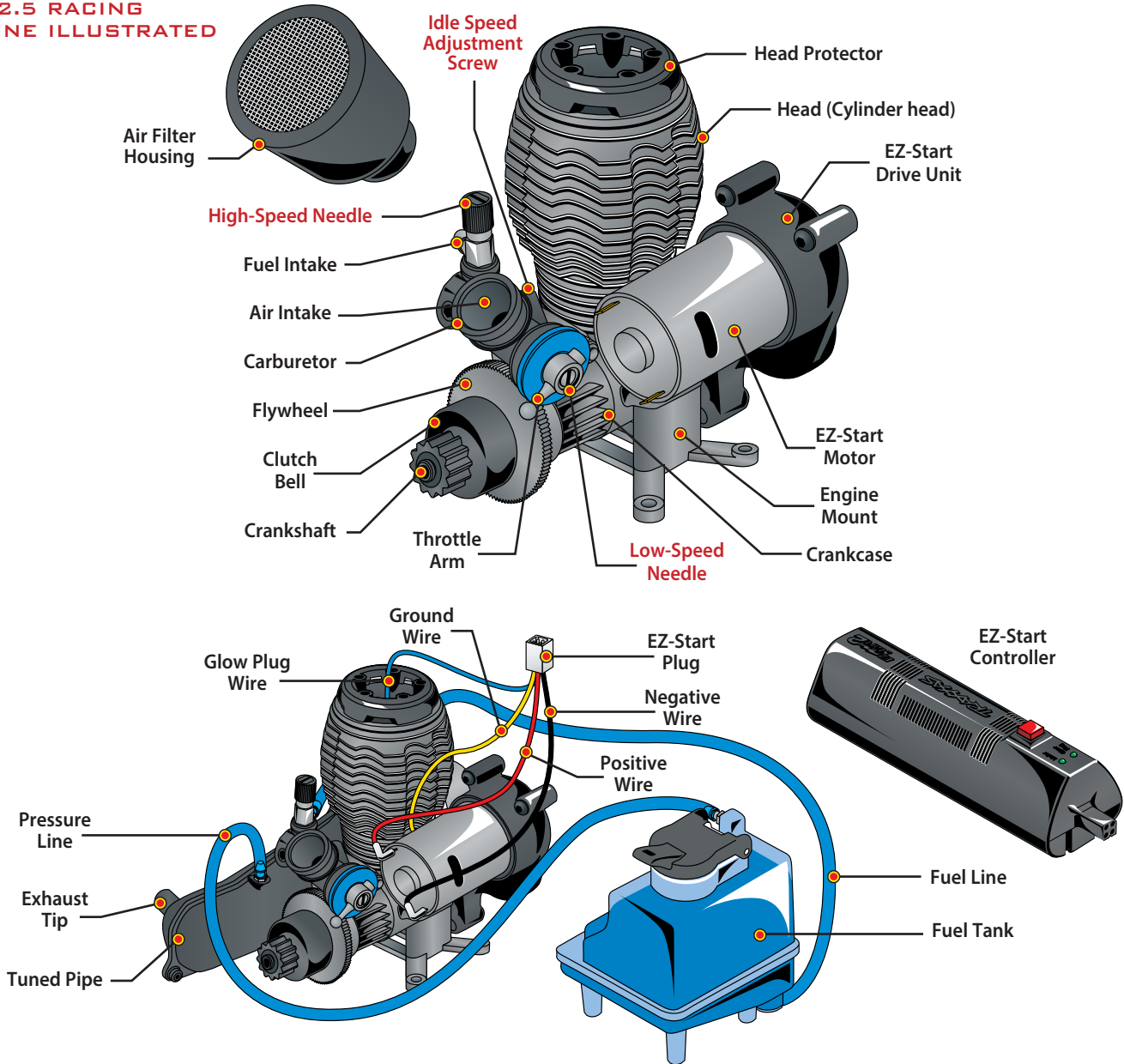

**TERMS TO KNOW**

You'll find these Nitro R/C engine terms throughout this section of the manual.

**.15** - .15 or "15" refers to the displacement of the engine. The TRX 2.5 Racing Engine is .15 cubic inches or 2.5 cubic centimeters (cc). The name "TRX 2.5" is derived from the cc measurement.

**ABC** - Abbreviation for aluminum, brass, and chrome. Refers to engine construction that consists of an aluminum piston that slides in a chrome-plated brass sleeve. The TRX 2.5 uses ABC construction.

**Air filter** - The air filter sits atop the carburetor and prevents harmful dust and dirt from entering the engine. Dirt ingestion is the number one cause of premature engine failure, so the engine should never be run without the air filter in place.

**BDC** - Bottom dead center. The bottom-most position of the engine piston stroke.

**Break-in** - Break-in is the procedure for running a brand new engine according to specific instructions. This correctly prepares the engine for normal running. The break-in procedure can be different for different makes of engines. Follow the Traxxas directions for break-in exactly.

**Carb** - Abbreviation for carburetor.

**Carburetor** - The carburetor atomizes (mixes) the fuel with the air so that the engine can burn it. There are two types of carburetors; slide carbs and barrel carbs. The TRX 2.5 uses the superior slide carburetor design.

**Clean-out** - Cleaning-out is a condition that occurs when the engine is accelerating and the fuel mixture becomes sufficiently lean to allow the engine to continue into its upper RPM power band. It is usually characterized by a noticeable decrease in blue exhaust smoke and a dramatic increase in engine speed.

**Combustion chamber** - The combustion chamber is machined into the bottom of the cylinder head. This is where the glow plug ignites the fuel. The shape of the combustion chamber is designed to promote more efficient burning of the fuel.

**Connecting rod** - The connecting rod transfers the piston motion to the crankshaft. The TRX 2.5 Racing Engine uses a "knife-edged" connecting rod. The aerodynamic, sharpened edges allow it to "slice" through the pressurized air/fuel mixture inside the crankcase.

**Crankcase** - The engine's "body" that contains all of the running mechanical components.

**Crankshaft** - The main shaft of the engine that holds the reciprocating assembly.

**Cooling fins** - The cooling fins are milled into the cylinder head and crankcase and cause heat to be drawn away from the engine. Heat is removed when it dissipates into the air, passing across the cooling fins. It is important to keep the fins clean of dirt and debris for maximum cooling efficiency.

**Cylinder head (head)** - The finned aluminum part on top of the engine that is responsible for dissipating most of the engine's heat. The combustion chamber is machined into the bottom of the head.

**Dyno** - Abbreviation for dynamometer. A precise piece of testing equipment that accurately measures engine power and torque output over the engine's entire RPM range.

**EZ-Start** - Traxxas on-board electric starting system. The system consists of a hand-held starter control unit and an on-board gearbox with an electric motor to spin the engine.

**Filter foam** - The oiled foam element inside the air filter housing. The filter foam in the TRX 2.5 must be thoroughly cleaned and re-oiled after every hour of run time.

**Fit** - Usually refers to the fit of the piston and sleeve. If the fit is tight, the piston will feel very tight at the top of the sleeve (top dead center), and the engine will have good sealing and compression. If the fit is loose, compression will be low and both the piston and sleeve should be replaced.

**Flame-out** - Occurs when the engine stops running at high RPM. Usually the fault of an excessively lean fuel mixture or glow plug failure.

**Fuel** - (20%, 33%) The TRX 2.5 must have model engine fuel to run. Traxxas Top Fuel™ is recommended. Fuel is sold in quarts and gallons from hobby dealers. The 20% and 33% labeling refers to the percentage of nitromethane contained in the fuel.

**Fuel mixture** - The ratio of fuel to air as determined by the needle settings of the carburetor.

**Fuel tubing (fuel line)** - The thick silicone tubing that carries fuel from the fuel tank to the carburetor.

**Glow plug** - The glow plug is located in the cylinder head at the top of the combustion chamber. It contains an element that glows red hot when voltage is applied. When the engine is being started, the heat from the glow plug ignites the fuel mixture and starts the combustion process.

**Glow plug driver** - This tool clips onto the glow plug and supplies the required voltage to light the glow plug element. It is also called an igniter. EZ-Start equipped engines do not require this separate tool.



**Header** - The aluminum tube that connects the exhaust system to the engine exhaust port. The length and diameter of the header must be carefully selected to extract the most power from the engine.

**High-speed needle (HSN)** - Adjusts the carburetors fuel/air mixture at high throttle openings.

**Idle speed** - The speed (RPM) the engine runs at when the transmitter's throttle trigger is at neutral.

**Idle speed screw (ISS)** - Located on the carburetor body. This screw adjusts the idle RPM of the engine.

**Lean** - A running condition where the engine is not getting enough fuel (for the available air). Symptoms include engine overheating, or the engine runs for a short time and then stalls, particularly at high speed. This is a dangerous condition that should be corrected immediately or it can ruin your engine.

**Leaning the mixture** - Turning either the high-speed and/or low-speed needle(s) clockwise to decrease the amount of fuel the engine receives.

**Low-speed needle (LSN)** - Needle valve that controls the fuel mixture at low throttle openings.

**Needle valve** - Valve consisting of a tapered needle that closes against a corresponding seat to regulate fuel flow.

**Nitro** - Abbreviation for nitromethane, a component of model engine fuel that improves fuel combustion and power output. Nitro also refers to a class of R/C powered by model engines instead of electric.

**Nitro content** - The amount of nitromethane used in the fuel. Usually measured as a percentage of the total fuel volume. Traxxas engines are optimized to use 10-20% nitro. 33% nitro may be used for racing.

**Nitromethane** - Nitromethane is a component in the fuel that increases power from the combustion process up to a point. Engines are generally optimized to use a range of nitro content for the best power.

**O-ring** - Rubber "O"-shaped ring used as a sealing gasket.

**Pipe** - Abbreviation for the tuned exhaust pipe on a nitro engine. See "Tuned Pipe".

**Piston** - The piston is the internal engine part that is attached to the upper end of the connecting rod and moves up and down in the cylinder sleeve. The precise fit between the piston and the sleeve creates a seal that allows the engine to have the required compression for combustion.

**Port** - Ports are openings in the sleeve that allow atomized fuel to enter the combustion chamber and burned exhaust gases to exit. The shape and location of the ports are a large factor in controlling the engine timing and power output.

**Priming** - Manually causing fuel to move from the fuel tank up to the carburetor. This is sometimes necessary after the engine has been sitting for a long period of time and all of the fuel has drained back to the tank. On a Traxxas model, this is done by holding your finger over the exhaust tip for one or two seconds while the engine is starting.

**Punch** - A term that refers to how quickly the model responds to throttle input or how quickly it accelerates.

**Rich** - A running condition where the engine is getting too much fuel for the available air. It is better to run an engine slightly rich to increase engine life. Excessively rich mixtures cause the engine to have sluggish performance with exaggerated blue smoke and unburned fuel coming from the exhaust.

**RPM** - Abbreviation for revolutions per minute (how many times the engine crankshaft spins in a minute).

**Sleeve** - Internal engine part that contains the piston. The precise fit between the sleeve and the piston creates a seal that allows the engine to have the required compression for combustion. The sleeve in a TRX engine is made of brass and is then hard-chrome plated.

**Slide carburetor** - The throttle on a slide carburetor closes and opens by sliding a barrel in and out of the carburetor body. This type of carburetor is preferred for performance use because it provides a less restrictive "straight-through" air path than the barrel carburetor design.

**Stall** - When the engine stops running, usually due to an incorrect fuel mixture setting or running out of fuel.

**TDC** - Top dead center. The top-most position of the engine piston stroke.

**Tuned pipe** - The tuned exhaust pipe usually consists of a specially-shaped metal or composite chamber with baffles that is designed to enhance the power output of the engine.

**Wear-in** - Fitment process that occurs during engine break-in where internal engine parts develop an even more precise matched fit through actual use under controlled circumstances.

**WOT** - Abbreviation for wide-open throttle.



**DANGER!** Model engine fuel is poisonous to humans and animals. Drinking the fuel can cause blindness and death. Handle with care and respect. Keep fuel out of reach of small children at all times! While driving, do not leave your fuel dispensing bottle on the ground where a child could have access to it. Follow fuel label warnings.

## THE FUEL

### Use the Right Fuel

It's imperative that you use the correct fuel in your TRX 2.5 Racing Engine for maximum performance and engine life. Traxxas Top Fuel<sup>®</sup> should be used to ensure correct engine lubrication, performance, and ease of tuning. Traxxas Top Fuel has been proven in thousands of engines, so you can count on it every day for great performance.



- Top Fuel is the only fuel which is 100% certified for use in Traxxas engines.
- Traxxas Top Fuel is made with just the right balance of the highest grade natural and synthetic lubricants to allow excellent throttle response and the best top-end performance, without sacrificing long-term durability.
- All of the components in the fuel are carefully selected from the best materials available and then custom blended to match the metallurgy and temperature characteristics of Traxxas engines.

You may use 20% or 33% nitro-content fuel. Try to use the same percentage all the time, avoid switching back and forth between fuels. We recommend that if you break in your engine on 20% fuel that you stick with that percentage. If you do move to a higher percentage, make sure you readjust your fuel mixture to compensate (see below).

### Choosing a Nitro Percentage

A commonly asked question is "what is the difference between 20% and 33% fuels?" Increasing the nitro in the fuel is almost like adding extra oxygen to the combustion process. It burns more efficiently, improves combustion, and delivers more power. When increased nitro is used, more of the other fuel components are then required inside the combustion chamber to maintain the perfect air/fuel ratio. Therefore, overall fuel mixtures need to be richened slightly (on the high speed needle, about 3/4 of a turn counterclockwise when changing from 20% to 33%). This allows greater fuel flow through the engine and promotes cooler running, even at the maximum lean settings.

If 33% improves power, then it seems that the highest nitro content available (beyond 33%) should always be used in the engine. In reality, there are practical limitations. Engines are designed to run best within a range of nitro percentages. How the engine is ported, the size of the combustion chamber, and other factors determine how much nitro can

be efficiently used in the engine. The TRX 2.5 Racing Engine responds exceptionally well to a maximum of 33% nitro, returning cooler temps, more power, and a smoother throttle response. For those who want to run higher nitro, 33% Top Fuel is the optimum nitro percentage for the TRX 2.5 Racing Engine. Increasing the nitro beyond 33% can introduce the need for engine modifications (ports, head shimming, etc.) to avoid starting and tuning difficulties. There are limits to how much nitro an engine can effectively use to make more power. Note that nitro is an expensive component in the fuel so 20% nitro blend is more economical for the sport user.

When using Traxxas Top Fuel, using higher nitro percentages does not cause the engine to wear out faster. 33% Top Fuel contains the same quality lubrication package as 20% Top Fuel. Some non-Traxxas high-percentage nitro racing fuels do sacrifice some lubrication in attempts to increase performance. We urge you to not take chances with your engine investment and use Top Fuel for consistent performance and long engine life.

### What about Other Fuels?

Can other brands of fuel be used besides Top Fuel? There are other fuels that can provide satisfactory performance; however, there could be long-term costs in the form of decreased engine performance, loss of tuning ease, and shorter engine life. Only use fuels that contain both castor and synthetic oil.

Everyone has an opinion or a claim to make about fuel. The engineering team at Traxxas has spent years developing TRX Racing Engines. No one knows more about the specific fuel requirements of Traxxas engines than Traxxas engineers. We strongly urge you not to take chances with your engine investment and use the Traxxas fuel made for the TRX 2.5 Racing Engine.

### Handling the Fuel

- **Follow all directions and warnings on the fuel can.**
- Keep the fuel tightly capped at all times. Some components in the fuel can evaporate very quickly and upset the balance of the fuel.
- Do not store unused fuel in the fuel dispenser. Immediately return fresh unused fuel back into the fuel can.
- Do not mix old and new fuel. Never mix different fuel brands together.
- Store the fuel in a cool dry location, away from any source of heat, ignition, or combustion.
- Read and follow the safety precautions on page 4 in this manual.

## Filling the Fuel Tank

Use the included fuel dispensing bottle to put fuel into the T-Maxx's fuel tank. To fill the fuel bottle, squeeze the air out, insert the dispenser tip into the fuel can, and release your grip on the bottle. As the bottle expands, fuel will be drawn into it.

To fill your model, flip up the spring-loaded cap on the fuel tank, insert the tip of the fuel bottle, and squeeze to dispense the fuel. Fill the tank until the fuel level reaches the base of the filler neck. Close the fuel tank lid, making sure it closes tightly.

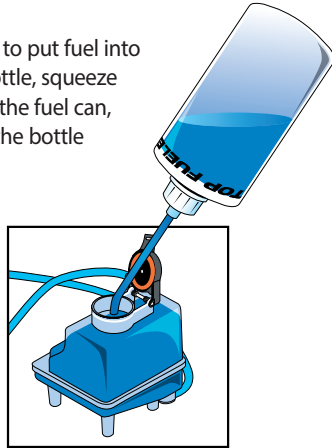

## Fuel Tank Seal Adjustment

The rubber seal on the fuel tank is important to the function of the engine. The fuel tank is pressurized by the exhaust system to provide reliable fuel flow. If the tank lid does not seal properly, an air leak will be created that can cause your engine to run erratically and be difficult to start. If necessary, the rubber O-ring tank seal can be adjusted for improved sealing by tightening the screw on the underside of the tank lid.

## THE AIR FILTER

The TRX 2.5 Racing Engine air filter is specifically designed to deliver maximum performance while protecting your engine from dust and dirt. Use only the supplied filter. **You will not improve engine performance by switching to an aftermarket filter**, and you may risk engine damage due to poor filtration.

The TRX 2.5 Racing Engine air filter assembly consists of 3 pieces:

1. A rubber filter base
2. A plastic housing consisting of a permanently assembled mesh cap and body
3. An oiled foam element

**You must clean the filter after every hour of run time, even if the filter looks clean. This includes the break-in time. Clean your air filter after break-in.** Dust (which is often too fine to see) and dirt constantly move through the filter anytime the engine is running. Even if you can't see dirt on the filter, it is present inside the foam after any amount of run

time. If you exceed the recommended cleaning intervals, your engine will be damaged. Engine damage or wear due to dirt ingestion is easy to detect, and one of the top causes of premature engine failure.

## Air Filter Cleaning Instructions

1. Remove the air filter from the carburetor bore by pulling the entire filter assembly firmly to the side to release it. Do not pull straight up.
2. Disassemble the filter. Pull the rubber air filter neck out of the filter body. With the base removed, the foam element is visible in the bottom of the filter body. Pull out the foam element.
3. Clean the filter parts by thoroughly washing all three pieces of the filter assembly in hot soapy water (dishwashing detergent works well). Repeat twice.
4. Thoroughly dry the parts with a clean towel or compressed air. Remember to wear your safety glasses when working with compressed air.
5. Oil the foam element with foam filter oil. Use the supplied Traxxas filter oil (part# 5263) or a high-quality, special-purpose foam filter oil, such as that used for off-road motorcycle and ATV engines. This type of filter oil is available at motorcycle pro-shops. Apply 30 drops of the Traxxas filter oil evenly to the top, bottom, and sides of the filter element (30 total drops divided among the 3 surfaces). Squeeze the filter element repeatedly to help spread the oil throughout. The filter element should be evenly colored by the oil. Even color indicates that the oil is distributed evenly. **Do not squeeze out excess oil. Note: Do not use the air filter oil for anything other than the air filter. It is not meant to be a lubricant.**
6. Reassemble the filter and install it on the engine, making sure the rubber filter neck fits securely on the carburetor with no gaps or air leaks.

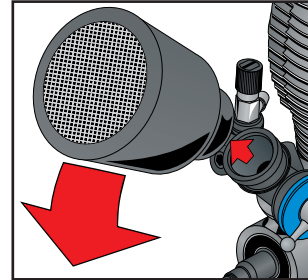



See page 27 for more information on how air density affects engine tuning.



A “turn” refers to tightening (“turning in”) or loosening (“turning out”) mixture needles. A “full turn” refers to turning the needle 360°, so a “1/2 turn” would be 180°, a “1/4 turn” would be 90°, and so on.

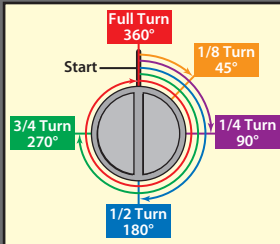

## THE CARBURETOR

### Understanding the Carburetor adjustments

The carburetor performs several functions. It controls the engine’s speed by restricting the intake of air and fuel into the engine. It atomizes the fuel (suspends the fuel droplets in the air) and also controls the air/fuel ratio of the mixture entering the engine (how much air for a given amount of fuel).

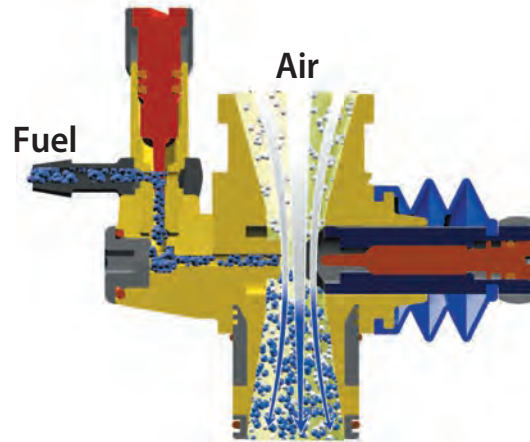

To help provide a better understanding of engine tuning and why it’s necessary, the following is a brief explanation of the air/fuel combustion process that takes place inside the engine.

In order to create the cylinder pressure that results in power, the engine burns the air/fuel mixture. Both air and fuel, in correct amounts, are needed for proper combustion. It is the carburetor’s job to mix the air and fuel together (atomize the fuel), in the correct proportion for the best possible combustion. This is the ideal air/fuel ratio. The ideal air/fuel ratio required for the engine remains roughly constant. Due to variations in atmospheric conditions (temperature, humidity, altitude, etc.), fuel flow adjustment valves (called fuel mixture needles) are required to meter the fuel and maintain the ideal air/fuel ratio in these ever-changing conditions. For example, colder air is more dense (more air molecules) for a given volume of air and therefore requires more fuel (more fuel molecules) to maintain the

correct air/fuel ratio. Warmer air is less dense (fewer air molecules) and therefore needs less fuel to maintain the correct air/fuel ratio. The tuning needles are there to adjust how much fuel is made available for the carburetor to mix with the available air (atomization).

Cold Air (More Dense)



(Warm Air) Less Dense

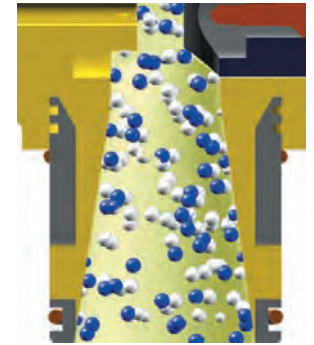

### THE FUEL MIXTURE NEEDLES

The amount of fuel metered and atomized by the carburetor is controlled by the two mixture needles, the high-speed needle and the low-speed needle. The low-speed needle is used to meter the fuel used by the engine at idle and low RPM (part-throttle) engine speed. The high-speed needle is used to meter the fuel when the throttle is open from part throttle to wide-open throttle (WOT). Two needles on the TRX 2.5 Racing Engine provide precise control of the air/fuel ratio across the engine’s entire RPM range.

The maximum possible fuel flow is always controlled by the high-speed needle. It works like the main water valve on a garden hose. Turn it clockwise to close the valve, counterclockwise to open it. When the throttle is at idle or partially open, the low-speed needle meters the fuel flow at the outlet (needle seat) where the fuel enters the carburetor venturi. This second valve acts like the spray nozzle at the end of the garden hose in our example. When you accelerate from idle, the throttle opens and the low-speed needle is pulled away from the needle seat. This allows more fuel to flow with the increased air flow. As the throttle is increased, the low-speed needle is pulled completely away from the needle seat, leaving it fully open. At that



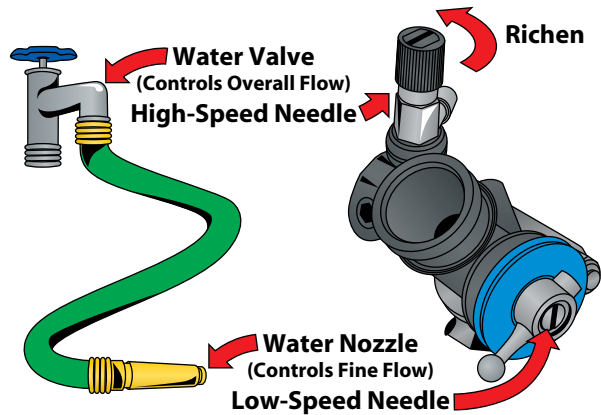

- Slightly lean fuel mixtures deliver stronger, more efficient combustion and more power, but with less lubrication.
- Slightly rich fuel mixtures deliver cooler running and more lubrication but with slightly less power.

Tuning the engine means finding the perfect balance between the two; excellent power to meet your needs while maintaining good lubrication for long engine life. **The optimal fuel mixture setting is rich** to provide a safety margin against having a lean condition if some variable changes (such as the temperature from one day to the next).

General fuel mixture settings are measured by the number of turns the needles are turned out from fully closed. The fuel mixture settings have been pre-set from the factory to typical break-in settings. Do not re-adjust your carburetor from the factory settings until after the engine is started and running, and you have been able to observe the engine running to assess what minor adjustments may be required to compensate for fuel, temperature, and altitude. Adjustments are usually made in 1/8 or 1/16-turn increments. If the engine sticks at top dead center (TDC), see page 34 for instructions on freeing the engine.

### The Idle Speed Adjustment

The idle speed adjustment screw controls the closed position of the throttle slide. When the throttle servo is in its neutral position, the throttle slide should be stopped against the idle speed adjustment screw. Always use the idle speed adjustment screw to control engine idle. See page 28 for instructions on adjusting the idle speed.

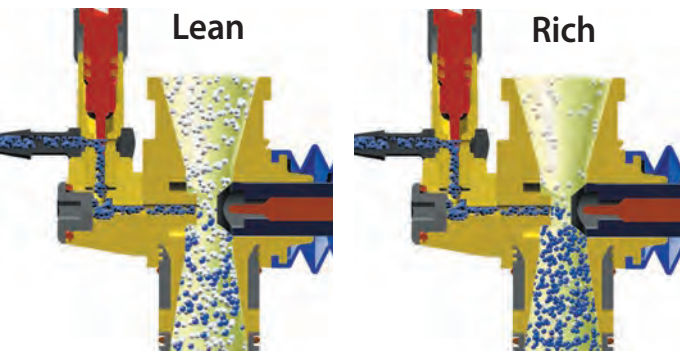

point, fuel metering is entirely controlled by the high-speed needle. Again, using our water hose example, when the spray nozzle at the end of our garden hose is fully open, then the main water valve can be used to adjust how fast the water flows.

The engine's performance is directly linked to the fuel mixture. Richening the fuel mixture increases the amount of fuel in the air/fuel mixture ratio, and leaning the fuel mixture decreases the amount of fuel in the air/fuel mixture ratio.



See *Tuning Your TRX 2.5 Racing Engine* on page 26 for complete information on adjusting the air/fuel mixture and idle speed.



### Factory Needle Settings

If your factory preset carburetor adjustments have been tampered with, use the following settings:

- Set the high-speed needle to 4 turns out from closed.
- Set the low-speed needle so the screw head (red in Fig. A) is flush (even) with the end of the slide (yellow in Fig. A).

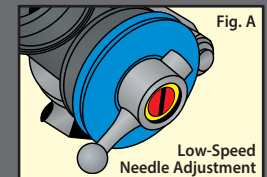

Always use the factory settings for initial starting. Only use these settings when the factory settings have been lost.



Higher nitro requires a richer fuel mixture. When running 33% fuel, richen your high-speed needle 3/4 turn if previously running 20% nitro and then re-tune the engine for maximum performance.

## THE TRAXXAS EZ-START ELECTRIC STARTING SYSTEM

The Traxxas EZ-Start brings the convenience of push-button electric engine starting to your T-Maxx. The EZ-Start consists of a hand-held control unit and an on-board motorized starter.

- Power for the EZ-Start system comes from a 7.2-volt rechargeable battery pack installed in the hand-held control unit.
- The engine glow plug is heated automatically by the EZ-Start system, eliminating the need to keep up with a separate glow plug igniter.
- The voltage to the glow plug is kept constant, regardless of the load placed on the starter by the starter motor.
- The "Glow Plug" LED (light emitting diode) on the control unit indicates the condition of the glow plug.
- The "Motor" LED indicates the status of the EZ-Start electric starter motor.
- The cush drive mechanism in the drive unit prevents damage to the gears caused by engine kickback.
- Smart Start™ protection circuitry prevents damage to the motor by cutting power if the load on the motor or other electronics exceeds safe limits.

### Charging the EZ-Start Battery

The included charger can be used to charge the included EZ-Start battery pack. **Do not charge batteries inside of an automobile. Read the Safety Precautions section of this guide.**

- 1. Plug the charger into a 12-volt automotive auxiliary power socket.**  
The charger is compatible with 12-volt automotive auxiliary power sockets only. The LED on the charger will glow red to indicate it is ready to charge a battery.
- 2. Connect the battery to begin charging.**  
Plug the battery into the charger. The charger's LED will flash green, indicating that charging has begun. The flashing green LED on the charger indicates the charge progress.
- 3. Disconnect the battery when charging is complete.** When the battery is fully charged, the LED will light solid green. The battery will be warm in your hand. Disconnect the battery.



### CHARGE PROGRESS

x1	1 green flash	0 - 25% charged
x2	2 green flashes	25% - 50% charged
x3	3 green flashes	50% - 75% charged
x4	4 green flashes	75% or more charged
	Solid green LED	100% charged

### CHARGER LED INDICATION

### MEANING

Solid Red LED	Ready for Charging
Slowly Flashing Green LED	Charging (see Charge Progress chart)
Solid Green LED	Battery Fully Charged
Flashing Red LED	Charger error

### Installing the EZ-Start Battery

1. Press the tab in the end of the battery compartment door to open (A).
2. Plug a fully charged 7.2-volt battery pack into the connector inside (B).
3. Twist the battery two or three times to twirl the battery plug wires. This helps hold the wire and battery in place when the battery is installed in the compartment (C).
4. Install the battery into the compartment and press the wires securely into place.
5. Snap the battery compartment door back on and lock the end tab (D).

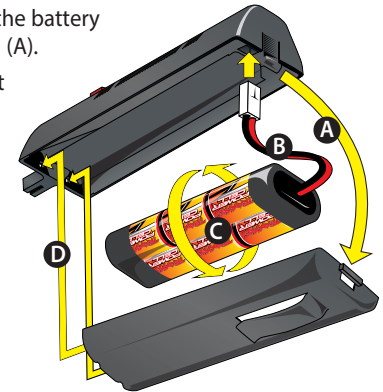

### Using the EZ-Start

Your EZ-Start controller plugs into a 4-prong receptacle in the center of the bed on your T-Maxx. When the red button on the controller is pressed, the EZ-Start motor begins to spin the engine, and power from the control unit heats the glow plug. Assuming all settings and preparations are correct, the engine should start almost immediately.

Each of the two status indicator LEDs on the hand-held control unit, the **Motor** LED and the **Glow Plug** LED, should light green while starting. If either LED fails to light while starting, there is a fault indicated with that function.

If the Glow Plug LED fails to light, the glow plug may be bad, or the glow plug wire may be damaged or disconnected.

If the Motor LED fails to light and the starter fails to operate, then the EZ-Start is in protection mode.

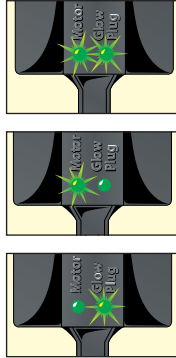

### Protection Mode

The EZ-Start uses Smart Start™ technology to monitor the condition of the system and detect failures. The controller monitors the load being placed on the EZ-Start motor. If the load becomes excessive, the system shuts off power to the motor to prevent costly damage to the motor and the controller. This may occur, for example, if the engine floods with fuel during starting. The starter spins at first, but when excessive fuel in the combustion chamber begins to lock up the engine, the starter motor slows under the heavier load. This causes the protection circuit to shut off the power to the motor. Allow at least 3 minutes for the starter motor to cool and the circuit to automatically reset before continuing. Use the time to find and eliminate the condition that caused the excessive load on the starter motor.

### Use a Strong Starter Battery

A weak starter battery, or one that has not been fully charged, may not deliver enough power to crank the engine over at the appropriate RPM to keep the piston from sticking at top dead center (TDC). A new engine will typically have a tight fit between the piston and the top of the sleeve. This is a tapered fit, and a tight piston sleeve fit on initial startup is desirable for those who want the best-performing engine. Make sure you are using a good quality battery pack that is fully charged (new batteries usually require several charge cycles to reach peak voltage and full capacity). This is especially important with a new engine that needs to be broken in. If the engine sticks at TDC, see page 34 for instructions on freeing the engine.

### Shutting Off The Engine

Turning off the switch for the radio will not shut off the engine. To shut off the engine, use the shut-off clamp on the fuel line. Squeeze the clamp closed to shut off the fuel supply to the engine. Don't forget to release it when you restart the engine.

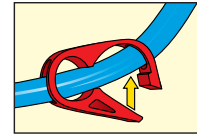

Avoid shutting off the engine by placing your finger over the exhaust outlet, especially if you are through driving for the day. This will leave more unburned fuel in the engine that could lead to harmful corrosion. **Always be careful not to touch the exhaust pipe after running, it can become very hot.**



When the EZ-Start controller is in protection mode, wait at least three minutes before attempting to start the engine to give the starter motor time to cool.



It's normal for your EZ-Start controller to become warm after repeated use.



See Important Points to Remember on page 4 for other precautions.



Never run your T-Maxx indoors. Since the TRX 2.5 Racing Engine exhaust fumes are harmful, always run your model outdoors, in a well-ventilated area.



Your TRX 2.5 Racing Engine doesn't usually require priming. If you do need to prime your engine, watch the fuel line carefully to avoid flooding your engine. See page 34 for information on clearing a flooded engine.



**Factory Needle Settings:** Your carburetor is preset at the factory to give the correct air-to-fuel ratio and idle speed for engine break-in. Do not adjust the carburetor unless you observe a poor running condition that requires correction (see page 21 for stock settings).



Higher nitro requires a richer fuel mixture. When running 33% fuel, richen your high-speed needle 3/4 turn if previously running 20% nitro and then re-tune the engine for maximum performance. See page 18 for more information.



## BREAKING IN YOUR TRX 2.5 RACING ENGINE

The TRX 2.5 Racing Engine uses a ringless, aluminum-brass-chrome (ABC) piston/sleeve construction. This type of engine design relies on a very precise running fit between the piston and sleeve for cylinder sealing. **Engine break-in is necessary to allow the piston and sleeve to develop an extremely precise fit and optimum cylinder sealing. Therefore, proper engine break-in is critical to achieving the fastest, most reliable engine performance.**

Allow yourself about 1 to 1½ hours to complete the break-in procedure. The engine break-in period will take 5 tanks of fuel in a T-Maxx. The break-in time is not the time to impress your friends with your new T-Maxx. **You must wait until the engine is fully broken in before attempting sustained high-speed running.** Patience and careful attention during break-in will reward you with the best-performing TRX 2.5 Racing Engine possible.

During break-in, your engine may appear to malfunction with symptoms like stalling, inconsistent performance, and fouled glow plugs. These are simply the normal "break-in pains" engines sometimes go through. They will disappear once your engine is fully broken in. Many owners report not experiencing any of these symptoms with TRX Racing Engines. **We recommend replacing the glow plug with a new one (included) after the engine break in procedure.** Use the supplied glow plug wrench to remove the glow plug from the engine's cylinder head (see page 15).

### Engine Break-in Procedure

The focus during break-in is to vary and limit the engine speed. This will be accomplished by accelerating and stopping at different rates for the first 5 tanks of fuel. As the engine begins to break-in, the duration and intensity of the acceleration will gradually increase. **Sustained high-speed running is not permitted until the 6th tank of fuel.** Perform the initial break-in on a large, flat, paved surface. **T-Maxx is very fast and by tanks 4 and 5 you will need plenty of room for the truck to run in. Apply all throttle and braking actions gently. Abrupt acceleration or braking could cause the engine to stall unnecessarily.**

- Special break-in fuels are not recommended. Use the same fuel you plan to use everyday.
- If possible, avoid breaking-in the engine on extremely hot or cold days (see page 26).
- Pay careful attention to the fuel level. Do not allow the fuel tank to run completely empty. An extremely low fuel level causes the mixture to run too lean. This could result in a burned glow plug or extremely high engine temperatures.
- **Do not attempt to break in the TRX 2.5 Racing Engine by idling it on a stand. This will produce poor results.**

- Keep extra Traxxas glow plugs handy. The break-in process can cause deposits to form on the plug, leading to plug failure.
- Change or clean your air filter after break-in.
- Follow the instructions exactly for each of the first 5 tanks of fuel.

### Starting Your TRX 2.5 Racing Engine for the First Time

Before you start your TRX 2.5 Racing Engine for the first time, make sure you have read all instructions and precautions in this manual. **Pay close attention to the tank-by-tank break-in instructions in the next section, and make sure you have read and understood them before you run your engine.**

**Your engine must be at room temperature (70°F or 21° C) or above the first time you start it.** If it's cooler than room temperature outside, remove all fuel and keep your T-Maxx indoors until you're ready to start it and then take it outside. If it's colder than 45°F, special considerations should be made. See cold weather break-in on page 26. We do not recommend running the model in temperatures below 35°F.

1. Turn on the radio system (see page 11).
2. Make sure the throttle trigger on the transmitter is in the idle (neutral) position.
3. Connect the EZ-Start controller according to the instructions on page 22.
4. Press the starter button in short two-second bursts and watch for fuel moving through the fuel line up to the carburetor. Watch closely! The fuel moves very fast. If the fuel doesn't move through the line within 5 seconds, prime the engine by briefly (one or two seconds) covering the exhaust outlet with your finger and pressing the EZ-Start button until the fuel is just visible in the carburetor fuel line. **Watch carefully! If the engine is primed too long, it will flood with fuel and stop turning.**
5. Once fuel reaches the carburetor, the engine should quickly start and idle.
6. Disconnect the EZ-Start controller from the model.
7. Proceed with the engine break-in.
8. Do not rev your engine with no load (wheels off the ground).

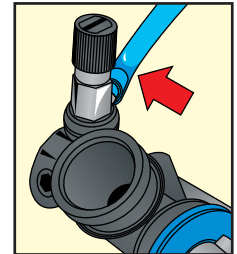

If your engine doesn't start, refer to the troubleshooting tips on page 35 or go online to [www.traxxas.com/support](http://www.traxxas.com/support). If your factory fuel mixture settings have been altered, refer to page 21. If you still have problems, contact Traxxas Customer Support at 1-888-TRAXXAS or [support@traxxas.com](mailto:support@traxxas.com).



- Tank 1**
1. Drive the model with the **body off**.
  2. Driving procedure: **Gently pull the throttle trigger to 1/4 throttle over a 2-second count. Then gently apply the brake to stop.** Count the two seconds out while accelerating: one thousand one, one thousand two, and then stop. Operate the throttle trigger as smoothly as you can. **Repeat this starting and stopping procedure until the first tank of fuel is nearly empty.**
  3. Look for thick blue smoke exiting the exhaust outlet. If there is no smoke, richen the high-speed needle 1/4 turn, by turning the needle counterclockwise.
  4. When the fuel tank is nearly empty, shut off the engine by pinching the fuel line connected to the carburetor (use the installed clamp).
  5. Let the engine cool for 15 minutes.
- Note:** If at any point the engine cuts out or stalls during gentle acceleration, richen the high-speed needle 1/4 turn by turning the needle counterclockwise.

- Tank 2**
1. From tank 2 forward, T-Maxx should be driven **with the body on**.
  2. Driving procedure: **Gently pull the throttle trigger to 1/2 throttle over a 2-second count. Then gently apply the brake to stop.** Count the two seconds out while accelerating: one thousand one, one thousand two, and then stop. **Repeat this starting and stopping procedure until the second tank of fuel is nearly empty.**
  3. When the fuel tank is nearly empty, shut off the engine and let it cool for 15 minutes.

- Tank 3**
1. Driving procedure: **Gently pull the throttle trigger to 1/2 throttle over a 3-second count. Then gently apply the brake to stop.** Count the three seconds out while accelerating: one thousand one, one thousand two, one thousand three, and then stop. **Repeat this starting and stopping procedure until the third tank of fuel is nearly empty.**

2. As the engine loosens, the idle speed may increase and cause the model to try to creep forward when stopped. Reduce the idle speed by turning the idle adjustment screw (see page 15) on the carburetor counterclockwise.
3. When the fuel tank is nearly empty, shut off the engine and refuel. From here on, you do not need to let the engine cool between tanks.

- Tank 4**
1. Driving procedure: **Gently pull the throttle trigger to full throttle over a 3-second count. Then gently apply the brake to stop.** Count the three seconds out while accelerating: one thousand one, one thousand two, one thousand three, and then stop. **Repeat this starting and stopping procedure until the fourth tank of fuel is nearly empty.**
  2. Apply the throttle gradually! Your finger should not reach full throttle until the end of the three-second count. T-Maxx may try to shift into second gear. If it does, reduce the throttle input. Do not let T-Maxx shift out of first gear.
  3. Keep your driving smooth and consistent.
  4. When the fuel tank is nearly empty, shut off the engine and refuel.

- Tank 5**
1. Driving procedure: **Gently pull the throttle trigger to full throttle over a 3-second count, hold for 2 more seconds, and then gently apply the brake to stop.** Count the five seconds out while accelerating. **Repeat this starting and stopping procedure until the fifth tank of fuel is nearly empty.**
  2. The model should now be shifting into second gear. If it is not, try turning the high-speed needle clockwise 1/8 turn to lean the fuel mixture slightly and test for shifting.
  3. When the fuel tank is nearly empty, shut off the engine and refuel.

- Tank 6**
- STOP! Clean your air filter before you proceed.** Refer to the instructions on page 19. During the sixth tank of fuel, the engine can be tuned for general performance use. Proceed to *Tuning your TRX 2.5 Racing Engine*.

TANK	THROTTLE	TIME	COOL	BODY	NOTES
1	1/4	2 seconds	15 minutes	Off	Apply throttle gradually.
2	1/2	2 seconds	15 minutes	On	Apply throttle gradually.
3	1/2	3 seconds	-	On	Reduce idle speed if necessary.
4	Full	3 seconds	-	On	Do not allow shifting to high gear.
5	Full	5 seconds	-	On	Accelerate over 3 second count, hold for 2 seconds.



**High Altitude Operation:** If you live in a high altitude region (5000 or more feet above sea level), the lower air density may require you to lean your high-speed fuel mixture slightly from the factory break in settings. Try this if you are experiencing difficult starting or extremely sluggish engine performance at high altitude.



As you gain experience in the hobby, you may discover that many people have differing opinions on what is the proper procedure to break-in a model engine. *Only use the Traxxas break-in procedure. Other break-in procedures could result in a weak, damaged, or otherwise poor performing engine.* The procedure outlined here was extensively tested and proven to yield better performing engines than other “common” break-in methods. Even if you have years of experience using model engines, please do not ignore this caution!



When tuning for performance, watch closely to notice when there is no longer any increase in speed or power when the high-speed mixture is lean. If you lean the high-speed mixture to the point that the engine cuts-out, hesitates, or stalls, you are well into the danger zone and engine damage is likely. Richen the high-speed needle 1/4 turn and retune.



For your convenience, the low-speed needle has a positive stop that prevents it from being over tightened and damaging the needle and seat. This also provides an easy way to gauge how many turns out from closed the low-speed needle adjustment is set to.



### Winter Break-in Tips

During the break-in process, the piston and sleeve wear into each other to form a precise fit. The engine needs to heat up to a temperature around 200 to 215°F to allow the piston and sleeve to achieve this fit properly. A precise fit between these two components is critical for proper compression and optimum performance. If the engine runs too cold during break-in, the piston and sleeve will not expand to their appropriate sizes for break-in, and this can lead to premature wear of these components. This wear may not become apparent until after winter has past, and the engine is operated under warmer running conditions.

- Warm the engine to approximately room temperature by removing all fuel and storing the vehicle inside at room temperature until just before starting the engine. An extremely cold engine can become difficult to start.
- After the engine is running, it is important to keep the temperature of the engine up around 200 to 215°F during break-in. In weather below 45°F, the TRX 2.5 Racing Engine will tend to run at lower temperatures between 160 to 180°F (when tuned at proper break-in mixture settings). This is too cool for break-in. **Do not lean the fuel mixture to increase engine temperature!** This will also decrease lubrication and cause your piston/sleeve to wear prematurely.
- Wrap the cooling head with a paper towel, clean rag, or sock to help keep the engine running around the recommended 200 to 215°F break-in temp. If too much heat is contained, the engine can actually run too hot. Make sure that you monitor the engine's temp closely for the first couple of tanks until you get the right amount of cover for the cooling head. This will, of course, depend on your current weather conditions. Adjusting the cover up and down, exposing more or fewer cooling fins, is a convenient way to regulate engine temps.
- For owners that do not have access to a temperature probe, a drop of water on the cooling head (around the glow plug area) can be used to estimate the engine's temperature. The drop of water should slowly sizzle for approximately 6 to 8 seconds if the engine is around 200 to 210°F. If the water sizzles for only a few seconds, then it is likely that it is over 220°F, and needs to cool down. If the water takes a long time or does not evaporate at all, then the engine is too cool.

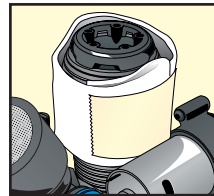

- We do not recommend that you operate your engine below 35°F. If you insist on running your vehicle below 35°F, be aware that nitro engines may be very difficult to start and tune at extremely cold temperatures. Also, at temperatures below freezing, nitro fuel can actually begin to gel up, and this can be harmful to the engine.

Follow the remaining break-in procedures as outlined in this Owner's Manual. This, along with the steps listed above, will ensure a good break-in for your new nitro engine, and provide many hours of enjoyment.

### TUNING YOUR TRX 2.5 RACING ENGINE

The engine's performance depends on the fuel mixture. Turn the mixture needles clockwise to lean the fuel mixture and counterclockwise to richen it. Leaning the fuel mixture will increase engine power up to the engine's mechanical limits. **Never run the engine too lean (not enough fuel flow). Never lean the engine so far that it begins to cut-out or stall.** Leaning the engine beyond the safe allowable limits will result in poor performance and almost certain engine damage. Indications of an overly lean mixture include:

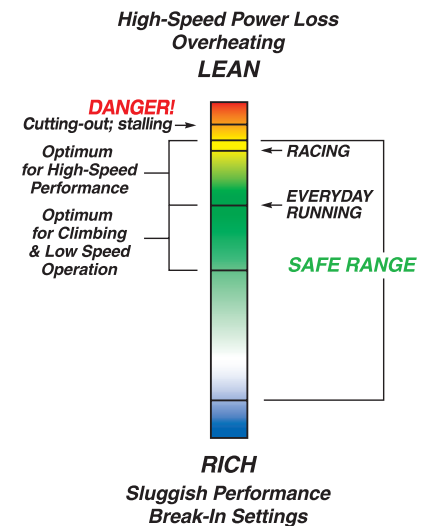

- **Cutting out or sudden loss of power during acceleration.**
- Overheating (temperature beyond 270° F at the glow plug).
- Little or no blue smoke coming from the exhaust.

If any of these conditions are present, stop immediately and richen the high-speed mixture 1/4 turn. The engine will probably be slightly rich at that setting and you can then retune for performance. Always tune for performance by starting rich and moving leaner toward the ideal setting. Never try to tune from the lean side. There should always be a light stream of blue smoke coming from the exhaust.

Before you begin tuning, the engine should be warmed up to its normal operating temperature and running slightly rich. All final tuning adjustments must be made to the engine at its normal operating temperature. You can tell the engine is running rich by noting any of the following:

- Sluggish acceleration with blue smoke coming from the exhaust.
- T-Maxx may not shift into second gear.
- There is unburned fuel spraying from the exhaust tip.
- Leaning the high-speed fuel mixture increases performance.

### High-Speed Fuel Mixture Adjustment

With the engine warm and running at a rich setting, gradually lean the high-speed fuel mixture in 1/16 turn increments. Make several high-speed passes after each adjustment to clear out the engine and note any change in performance. The TRX 2.5 is extremely powerful. Remember to apply the throttle gradually to prevent wheelies or loss of control. Continue this procedure until there is no longer any performance improvement. **If any one of the following conditions occurs, the fuel mixture is already past the maximum safe lean setting:**

1. There is no longer any performance improvement.
2. The engine begins to cut out at high speed (Danger!).
3. There is a sudden loss of power during acceleration (Danger!).
4. The engine begins to overheat. Symptoms of overheating include:
  - Steam or smoke coming from the engine (not exhaust)
  - Hesitation or stalling during acceleration
  - Popping or clattering sound when decelerating (detonation)
  - Fluctuating idle speed
  - Temperature measurement above 270°F at the glow plug (A temperature reading above 270°F alone does not necessarily indicate overheating. Look for other symptoms of overheating combined with temperature for a more accurate warning)

Richen the fuel mixture to the optimum setting by richening the high-speed needle at least 1/8 turn counterclockwise and retest. This setting will extend engine component life.

### Low-Speed Fuel Mixture Adjustment

The low-speed mixture is always set after the high-speed needle is correctly adjusted. The low-speed mixture is set using the “pinch test”:

1. Once the engine is warm, do several high-speed runs to confirm that the high-speed needle is set correctly.

2. Bring the vehicle in and pinch closed the fuel line going into the carburetor (use the engine shut-off clamp). The engine should run for 2-3 seconds, speed up, and then shut off.
3. If the engine runs longer than 3 seconds, then lean the low-speed needle 1/16 turn, make several more high-speed runs, and retest.
4. If the engine shuts off immediately without speeding up, then richen the low-speed needle 1/8 turn, make several more high-speed runs, and retest.

When the low-speed needle is set correctly, the engine’s throttle response should be very quick, even to the point of making it difficult to keep T-Maxx from doing a wheelie when you accelerate!

### Fuel Mixture Adjustment Chart

If the...	is..	then the air density is...	adjust (correct) the fuel mixture to be...
Humidity	Lower	Slightly more dense	Slightly richer
	Higher	Slightly less dense	Slightly leaner
Pressure (barometer)	Lower	Less dense	Leaner
	Higher	More dense	Richer
Temperature	Lower	More dense	Richer
	Higher	Less dense	Leaner
Altitude	Lower	More dense	Richer
	Higher	Less dense	Leaner
Nitro %	Lower	-	Leaner
	Higher	-	Richer



When adjusting the low-speed fuel mixture, it is very important to make several high-speed runs with T-Maxx between adjustments to clear out any excess fuel. Perform the pinch test immediately after. If the engine is allowed to idle for a long period of time, it could “load up” with fuel and give you an inaccurate measurement from your pinch test.



Higher nitro requires a richer fuel mixture. When running 33% fuel, richen your high-speed needle 3/4 turn if previously running 20% nitro and then re-tune the engine for maximum performance. See page 18 for more information.

### Idle Speed Adjustment

Once the high- and low-speed mixtures have been set, reduce the idle speed to the minimum reliable idle speed. Remember, this adjustment should be made while the engine is running at normal operating temperature. Always use the idle speed adjustment screw to control engine idle.

1. When the throttle servo is in its neutral position, the throttle slide should be stopped against the idle speed adjustment screw.
2. Turn the screw counterclockwise to reduce the idle speed or clockwise to increase it. The idle speed should be set as low as possible while still maintaining reliable running characteristics.

### Fine-Tuning the Carburetor

After fine-tuning your TRX 2.5 Racing Engine at the end of the break-in procedure, no major adjustments to the fuel mixture are usually necessary. Make note of the temperature, humidity, and barometric pressure at the time you finished fine tuning your carburetor. Current weather conditions can be found online from national websites, local TV news websites, and television. This information will be considered your baseline setting.

You may need to adjust your carburetor needles to compensate for changes in temperature and barometric pressure (air density) from day to day. Generally, you'll need to richen the fuel mixture when the weather is colder than your baseline temperature and the air density is higher. Lean the fuel mixture when weather is warmer than your baseline temperature and the air density is lower. The chart below provides general guidelines on how weather conditions affect air density when they move higher or lower than your baseline setting (see page 20 for detailed info on how air density affects mixture settings).

### Tuning the Engine by Temperature

The following procedures require an optional infrared temperature probe or on-board temperature gauge. Engine temperature can be used as an effective tuning aid when you understand the relationship between engine temperature and ambient temperature. The engine operating temperature, when tuned for maximum performance, will vary according to atmospheric conditions, engine load, gauge accuracy, and many other factors. The atmospheric condition that has the most influence on engine temperature is air temperature. Expect the engine temperature to vary almost in direct proportion to air temperature. Assuming you tuned the engine for the same maximum performance each day, the engine will run about twenty degrees hotter when it's ninety degrees outside

than it would in seventy-degree weather. For this reason, we cannot give you a definitive temperature range that indicates the best possible engine tuning.

**There is NO optimal temperature that can be used as a target to deliver the best engine tuning. Do not rely on a temp gauge alone to tune your engine. Tune the engine by paying very close attention to how it responds to changes in fuel mixture (more smoke/less smoke, fast/sluggish, reliable/stalling, smooth sound/ muffled sound, etc).**

Once the engine is tuned, then observe the temperature.

The temperature gauge can aid you in tuning by giving you a relative indication of how your adjustments are affecting the engine and to help prevent you from reaching excessive engine temperatures. For example, as you lean the fuel mixture, the engine performance will increase along with the temperature. If you continue to lean the fuel mixture and the temperature increases but the engine performance does not change, then you have exceeded the maximum safe lean setting. Make note of the engine temperature. Generally, try to keep your engine from exceeding 270°F when measured at the glow plug. If necessary, increase airflow to the engine by cutting out the rear of the body, windshield, and front valance. In some situations, the engine may perform very well with no stalling, lagging, or hesitation at temperatures above 270°F, particularly in very hot climates.

If richening the fuel mixture to bring the temperature down to 270°F results in poor, sluggish performance (engine never cleans out) then return the engine back to a satisfactory state of tune based on how it sounds and performs (always with a visible stream of blue smoke coming from the exhaust). If engine temperature is exceeding 270°F with proper cooling and no signs of abnormal running, then avoid running the engine at its maximum lean setting. Watch closely for **any** signs of overheating. Richen the fuel mixture slightly to provide a safety margin of additional cooling lubrication. Symptoms of overheating include:

- Steam or smoke coming from the engine (not exhaust)
- Hesitation or stalling during acceleration
- Popping or clattering sound when decelerating (detonation)
- Fluctuating idle speed



### INTRODUCTION

Your TRX 2.5 Racing Engine is broken in, the fuel mixture is balanced, and the idle is set...now it's time to have some fun! This section contains instructions on making adjustments to your T-Maxx. Before you go on, here are some important precautions to keep in mind.

- **Don't run your T-Maxx in water, mud, snow, or wet grass.** It's tempting, but water and mud are easily drawn through the air filter and will severely damage the engine. Small amounts of moisture can cause electronics to fail and loss of control over your T-Maxx. Snow is frozen water. Do not drive the T-Maxx in snow or the electronics could be damaged by water.
- The TRX 2.5 Racing Engine is extremely powerful. Remember to apply the throttle gradually to prevent loss of control. T-Maxx is very fast and responsive and is intended for experienced drivers. Do not drive over the limits of your reflexes and ability. Drive with caution at all times and gradually build up your ability to maintain control at T-Maxx's upper performance limits.
- Don't hold T-Maxx off the ground and rev the engine excessively with no load on the engine. This practice could result in internal engine damage. Avoid over-revving the engine when T-Maxx is airborne after a jump.
- Avoid excessive high-speed running for extended periods of time or over long distances. This could cause the engine to build up enough speed to exceed maximum safe RPM limits.
- Don't drive your T-Maxx with drivetrain damage of any kind. The engine could be damaged due to overloads caused by drivetrain friction, or over-revving caused by loose or missing parts.
- Don't tow anything with your T-Maxx. The engine is cooled by airflow created by speed. Towing creates a high load on the engine, and at the same time limits cooling of the engine due to low vehicle speed.
- If your T-Maxx gets stuck, stop driving immediately. Move the vehicle and then continue driving.
- Never turn off the radio system while the engine is running. The truck could run out of control.

### Forward and Reverse Operation

Forward and reverse gears are selected with the shift button located in the transmitter handle grip. The switch is normally in the down, or forward, position.

- To shift into reverse, bring your T-Maxx to a **complete stop** and push the shift button up. Accelerate to engage the gear.
- To return to forward gear, repeat the same procedure but move the shift button down.
- T-Maxx will not shift between forward and reverse unless the truck is stopped. If it will not shift, then refer to the troubleshooting section on [www.Traxxas.com](http://www.Traxxas.com) or call Traxxas support.

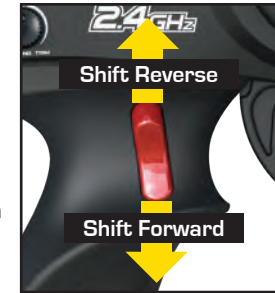

### Driving Tips

- Monster trucks by design have a high center of gravity that requires a different driving technique. To prevent rollovers, slow down as you approach turns and then apply moderate throttle through the turns. This technique will help T-Maxx grab the surface and turn sharper.
- Do not apply brakes and turn the wheel at the same time. You could tip the truck over.
- When jumping, apply some throttle while T-Maxx is in the air to keep the truck's nose up and land level on all 4 wheels. Be careful not to over-rev the engine or land at full throttle. Either could seriously damage your T-Maxx. If the nose of the truck is too high, then quickly tap the brake to level the truck in the air.
- Drive over large obstacles (such as curbs and rocks) at an angle, instead of head on. This will allow the suspension to articulate and absorb the impact much easier.
- Even though T-Maxx is capable of high speed in reverse, it is very difficult to control while driving in reverse. Limit your reverse speed to prevent crashing or flipping your T-Maxx.
- Change or clean your air filter element after each hour of running. This is critical for the life of your engine. Running time includes the engine break-in period.

## TUNING ADJUSTMENTS

### Adjusting the Slipper Clutch

The T-Maxx features an adjustable slipper clutch on the spur gear to help protect the drive train from sudden shock loads (such as landing off of jumps with the engine at full throttle). Under normal conditions the slipper clutch should not slip. Before adjusting the slipper clutch, turn the model off. Do not adjust the slipper clutch while the engine is running.

Use the supplied glow plug (universal) wrench to tighten the slipper nut (clockwise) until it stops, and then back the nut out 1/4 of a turn. If you notice any decrease in performance after making changes to the slipper clutch adjustment, then it may be too loose. The slipper must not be allowed to slip during normal acceleration or the slipper could be damaged.

### Adjusting the Two-Speed Transmission

The T-Maxx comes equipped with a two-speed transmission. When the shift point on the transmission is adjusted correctly, it will maximize acceleration and improve drivability. If necessary, use the supplied 2.0mm hex wrench to adjust the shift point.

1. Stop the engine.
2. Remove the large rubber plug from the transmission housing.
3. Look into the hole in the transmission housing and rotate the spur gear until the access hole in the aluminum drum is visible.
4. Once the access hole is visible, hold the spur gear and use your finger to turn the primary gear shaft, which extends from the transmission housing. Turn it clockwise. Note that you will see two set screws pass under the access hole. As you slowly turn the primary gear shaft counterclockwise, the first set screw that becomes visible holds the two-speed mechanism on to the shaft. Do not loosen this screw. The second set screw is the adjustment screw.
5. Insert the 2.0 hex wrench through the clutch drum and into the adjustment set screw.

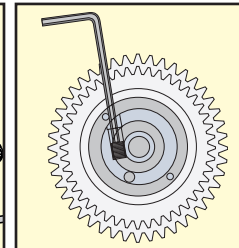
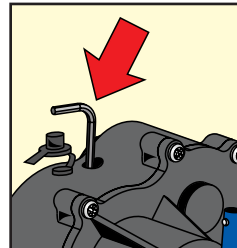
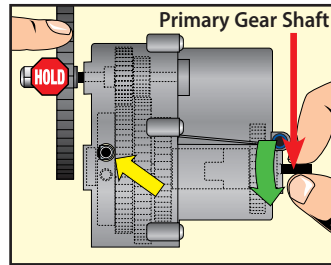

6. Turn the adjustment screw 1/8 turn clockwise to raise the shift point (later shifts). Be careful not to over tighten the adjustment screw or you may damage the tension spring. Do not make constant adjustments or you will loosen the screw's locking device.
7. Turn the adjustment screw 1/8 turn counterclockwise to lower the shift point (earlier shifts). Be careful not to loosen the adjustment screw too much or you may cause the screw and spring to fall out (requiring major disassembly and repair).
8. Use 1/8-turn increments to find the approximate desired shift point.
9. Check performance by running a test lap after each adjustment.
10. Use 1/16-turn increments to fine-tune the shift point.
11. Be sure to reinstall the access plug to prevent dirt from entering the transmission.

### Adjusting the Toe-in

Your T-Maxx comes from the factory with zero degrees of toe-in in the front, and one degree of toe-in in the rear. You can adjust the toe-in on the front and rear of the truck. Set the steering trim on your transmitter to neutral. Now, adjust your steering turnbuckles so that both front wheels are pointing straight ahead and are parallel to each other (0 degrees toe-in). This will ensure the same amount of steering in both directions. Adjust the rear toe control links so that the rear wheels have 1° of toe-in.

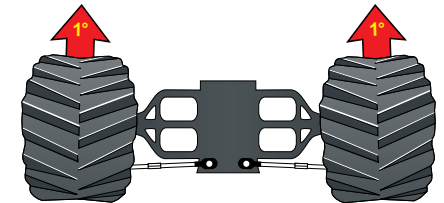
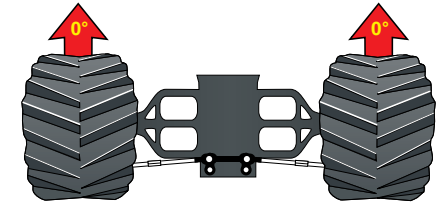

### Adjusting the Camber

Two pivot balls are accessible through the spokes of each of the wheels on your T-Maxx. From the factory, the pivot balls are completely tightened into the suspension arms, which give each of the wheels  $-1^\circ$  of camber. Unscrewing the bottom camber pivot ball with a 2.5mm hex wrench will increase the wheel's negative camber. You should not adjust the top pivot ball; unscrewing it will increase positive camber and will also change the wheel's toe-in.

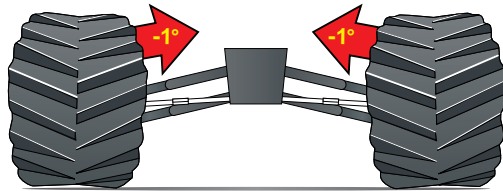
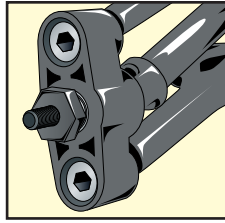

### Fine Tuning the Shocks

The eight shocks (oil dampers) on your T-Maxx have tremendous influence on its handling. Whenever you rebuild your shocks or make any changes to the pistons, springs, or oil, always do it carefully and in sets (front or rear). Piston head selection depends on the range of oil viscosities that you have available. For example, using a two-hole piston with lightweight oil will give you the same damping as a three-hole piston with heavier oil. We recommend using two-hole pistons with a range of oil viscosities from 10W to 40W (available from your hobby shop). The thinner viscosity oils (30W or less) flow with less resistance and provide less damping, while thicker oils provide more dampening. Use only 100% pure silicone shock oil to prolong seal life. From the factory, the T-Maxx uses 30W oil.

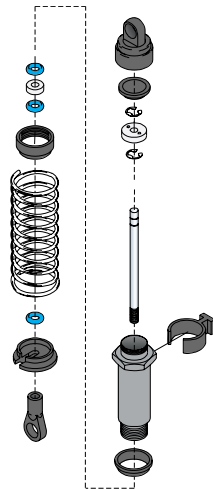

The ride height for the T-Maxx can be adjusted by adding or removing the clip-on spring pre-load spacers. Note that changes in ride height will occur when changes in shock angle or spring rates are made. You can compensate for ride height changes by changing the pre-load spacers on the shocks.

### ADJUSTING THE SUSPENSION

The T-Maxx has adjustable suspension so that it may be optimized for different kinds of terrain and driving styles.

#### Caster Adjustment

The T-Maxx offers the ability to adjust the caster angle of the front suspension. Caster adjustment may be used to influence the understeer/oversteer handling characteristics of the T-Maxx. Increasing the caster angle will increase the tendency of the truck to oversteer (less traction on the rear tires, more traction on the front tires), while decreasing the caster angle will cause the truck to have a tendency to understeer (push in the turns). This effect becomes more pronounced at higher steering angles and higher spring rates. Caster is adjusted by repositioning the shims on the pivot point of the upper suspension arms.

The stock caster setting is 7 degrees, with one shim at each end of the arm. Reduce the caster angle to 4 degrees by removing the rear shim and inserting it next to the front shim. The caster angle can be increased to 10-degrees by removing the front shim and inserting it next to the rear shim.

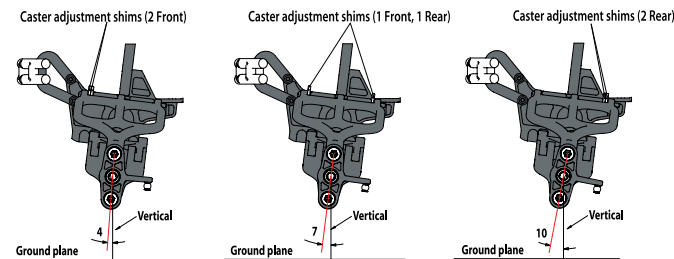

Factory toe-in settings can be achieved by installing the rod ends on the turnbuckles until they bottom out against the shoulder. If you desire more toe-out, the tips of the rod ends must be trimmed to allow them to screw down further onto the turnbuckle threads.



A camber gauge (available at your local hobby shop) can be a useful tool for alignment setting.



For easier access to the rear-most shock mounting screw, remove the one end of the rear turnbuckle. In the front, remove the suspension pin from the lower front suspension arm to gain easier access to the lower shock mounting screws.

### Shock Mounting Positions

Big bumps and rough terrain require a softer suspension with the maximum possible suspension travel and ride height. Racing on a prepared track or on-road use requires a lower ride height and firmer, more progressive suspension settings. The more progressive suspension settings help reduce body roll (increased roll stiffness), dive during braking, and squat during acceleration.

The innermost upper shock mounting position (0) on the shock tower is intended for use with the first generation T-Maxx suspension arms.

With the second generation arms (2.5-powered T-Maxx), position (0) can be used for tuning with the inner pair of lower shock mounting positions on the arm (1,2). It is not compatible with lower shock mounting positions 3 and 4 on the second generation (2.5-powered T-Maxx) arms. Upper shock mounting position (A) should generally be used with lower shock mounting positions 1 and 2. Generally, upper shock mounting position (B) should be used with lower shock mounting positions 3 and 4. Other combinations may be used to achieve individualized suspension settings.

### Lower Shock Mounting Positions

In the out-of-the-box configuration, the shocks are installed in position (A) on the shock tower and position (2) on the lower suspension arm. This setting allows for moderate suspension travel and ride height. The more vertical position of the shocks allows for lower shock progression and the soft, plush feel that's characteristic of the T-Maxx.

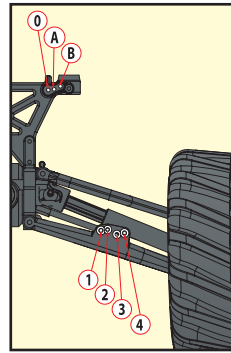

The outer pair of holes on the lower suspension arm should be used to lower the ride height of the T-Maxx and increase the spring force (at the wheel). This setting will improve high-speed cornering on smoother terrain by lowering the center of gravity and providing a firmer suspension feel. Body roll, brake dive, and squat will be reduced.

**Spring rate** (at the wheel) increases as the lower shock mounting position is moved from position (1) to position (4). This is equivalent to using stiffer springs. Use higher spring rate settings for flatter terrain with smaller and fewer bumps and lower spring rate settings for bigger bumps.

**Ride height** decreases as the lower shock mounting position is moved from position (1) to position (4). Each pair of lower shock mounting holes (1,2 and 3,4) has equal ride height. Use lower ride height for high-speed cornering and flat terrain, and when racing on relatively smooth tracks. Increase the ride height for rougher terrain and tracks.

### Upper Shock Mounting Positions

The upper shock mounting positions will have the opposite effect on the suspension that the lower shock mounting positions.

**Spring rate** (at the wheel) increases as the upper shock mounting position is moved from position (A) to position (B).

**Ride height** is not affected by changes in the upper shock mounting position.

Use the chart below to see the effect of the various shock mounting positions. The horizontal length of the lines indicates the amount of suspension travel. The angle or slope of the lines indicates the spring rate (at the wheel).

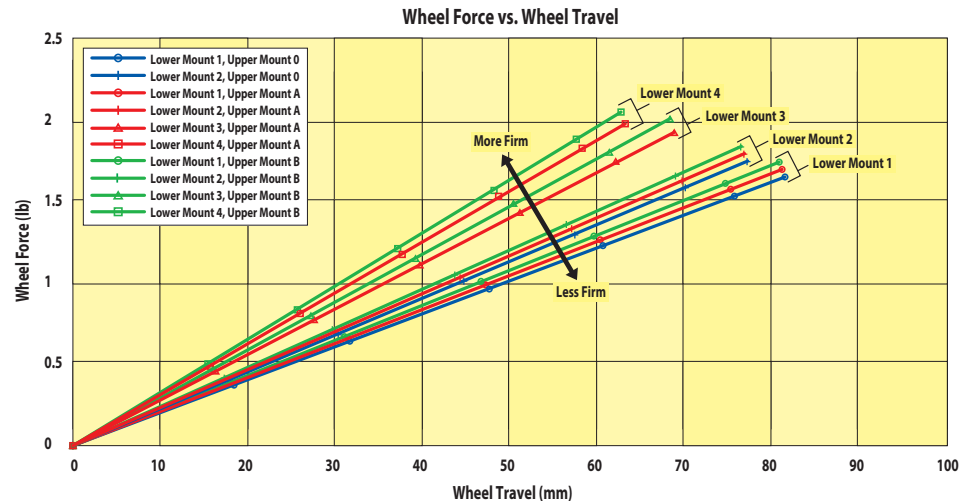



Your T-Maxx requires timely maintenance in order to stay in top running condition. **Neglecting the maintenance could allow dirt, deposits, and moisture to build up inside the engine, leading to internal engine failure.** The following procedures should be taken very seriously.

## After each hour of running:

- Clean and re-oil the air filter. The instructions for this procedure are on page 19. **We cannot stress enough the value of cleaning your air filter at the scheduled intervals. Do not neglect your air filter maintenance!**
- Clean the outside of the engine of accumulated dirt, oil, and grime. Accumulated grime will decrease the engine's ability to cool itself.

## After each running session:

- Perform after-run maintenance on the engine. This clears the engine of destructive moisture and other corrosive deposits. **This is extremely important for the life of the engine. See below for after-run maintenance procedures.**
- Inspect the vehicle for obvious damage or wear. Look for:
  1. Loose or missing screws
  2. Cracked, bent, or damaged parts
  3. Cut or loose wiring
  4. Cut or kinked fuel lines
  5. Signs of fuel leakage
- Inspect the gears for wear, broken teeth, or debris lodged between the teeth.

## Other periodic maintenance:

- **Slipper clutch pegs** (friction material): The slipper clutch pegs will wear over time and require replacement. The life of the pegs depends on how the slipper clutch was adjusted and how the T-Maxx was used. If the slipper will not tighten or you are seeing signs of wear on the face of the gear, then the pegs should be replaced.
- **Piston/sleeve:** The life of the piston and sleeve will vary greatly with how the engine was used and maintained. The piston

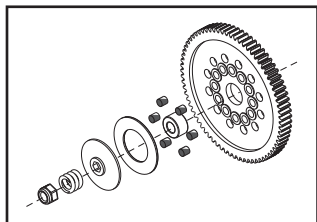

and sleeve should be replaced when they no longer seal effectively (loss of compression). Symptoms include the engine being difficult to start when warm, stalling when warm, and stalling when throttle is suddenly closed to idle. Replace the wrist pin and G-clip whenever the piston and sleeve are replaced.

- **Connecting rod:** The connecting rod should be replaced when the piston and sleeve are replaced or after three gallons of fuel, whichever comes first. Also replace the piston wrist pin and G-clip whenever the connecting rod is replaced. As with other internal engine components, connecting rod life depends on engine usage and the quality and frequency of engine maintenance.
- **EZ-Start™:** The crush drive elements in the EZ-Start drive unit should be inspected after 3-gallons of fuel. If the crush drive elements appear deformed or hardened, then they should be replaced. Inspect the EZ-Start gears for any signs of wear. Damaged gears should be replaced. Coat the gears with a thin layer of white lithium grease.



## After-run Procedure

You must perform after-run maintenance on your Traxxas engine whenever the model will be stored for longer than a few hours. Taking the time to prepare your engine for storage will reward you with longer engine life, easier starting, and better performance. When a nitro engine is shut off, some excess unburned fuel remains in the engine. The methanol in model engine fuel is hygroscopic, which means it easily attracts and absorbs moisture. This moisture can cause rust and corrosion on the steel engine parts (crankshaft, bearings, wrist pin, and starter shaft) if the fuel is not removed from the engine. There are after-run oil products available from your hobby dealer or you can use WD-40™, a common household lubricant. To ensure your TRX 2.5 engine is protected from internal corrosion, use the following procedure:

1. Whenever possible, shut off the engine by pinching the fuel line closed. This allows most of the excess fuel to be consumed by the engine. Be sure the throttle is in the idle position. You may



If the engine is worn or damaged enough to require replacing the piston, sleeve, or connecting rod, consider exchanging your old engine for a brand new engine under the terms of the Traxxas Lifetime Engine Replacement Plan (ERP). It could save you time and effort. Details are in your model's documentation package.



The TRX 2.5 Racing Engine is designed to be easy to rebuild. Critical engine components, such as the crankcase, crankshaft, and engine bearings, are made to extremely high quality standards and should under normal circumstances outlast multiple sets of pistons, sleeves, connecting rods, and wrist pins (reciprocating assemblies). It could be more economical for you to continue to use your good bearings and crankshafts, and simply replace the reciprocating assembly as needed. Engine assembly is not difficult and replacing the reciprocating assembly does not require any special tools or skills.





Denatured alcohol (available from home centers and paint supply stores) in a spray bottle is an extremely effective cleaner. Be sure to wear safety glasses and gloves when working with denatured alcohol.



Be sure to follow proper maintenance and storage procedures to avoid damage to your engine and other components of your T-Maxx.



Don't put the fuel from your tank back into your fuel jug. Dispose of it properly, following city or county regulations.



Always wear eye protection when using compressed air or spray cleaners and lubricants.

1. have to pinch the fuel line closed for several seconds before the engine stops.
2. Completely empty the fuel tank. Use your fuel-dispensing bottle to suck out the old fuel. Do not mix the old fuel with your fresh fuel supply. If you leave fuel in the tank, transporting or handling your T-Maxx may cause fuel to run into the engine.
3. With the fuel tank empty and the throttle at the idle position, try to start the engine. The engine will most likely start and run for a few seconds as it uses up any fuel remaining in the engine and fuel lines.
4. Once the engine stops, clean the outside of the engine with compressed air or spray motor cleaner. Once the engine is clean and dry, remove the glow plug power wire, glow plug, and air filter.
5. Open the throttle fully and spray a one-second burst of WD-40 into the carburetor and into the glow plug hole (Caution! Wear safety glasses to prevent spray from getting into your eyes). If you are using after-run oil, follow the manufacturer's instructions.
6. Place a rag or paper towel over the engine to catch any WD-40 or after-run oil that may come out of the carburetor or glow plug hole.
7. Connect the EZ-Start controller to the model and spin the engine for 10 seconds.
8. Remove the rag or paper towel and repeat steps 5–7 two more times.
9. Clean and re-oil the air filter so it will be ready for use next time. See page 19 for air filter maintenance instructions.
10. Replace the glow plug, reconnect the glow plug power wire, and reinstall the air filter.

#### Clearing a Flooded Engine

If the engine is primed for too long during startup, then it can become flooded with fuel. When the engine is flooded, it will no longer turn due to excess fuel in the combustion chamber preventing upward movement of the piston. Use the following procedure to clear a flooded engine:

1. Remove the blue glow plug wire.
2. Remove the glow plug and gasket with the glow plug wrench supplied with your model. A 5/16 or 8mm nut driver will also work.

3. Turn the model upside down and plug in the EZ-Start controller.
4. Push the EZ-Start button for several seconds to clear the engine of excess fuel. Do not look into the glow plug hole while the engine is spinning or you could spray fuel into your face!
5. Turn the model over and reinstall the glow plug and gasket.
6. Reconnect the blue glow plug wire to the glow plug.
7. Reconnect the EZ-Start controller.
8. Do not prime the engine. Pull the throttle to 1/2 throttle and push the EZ-Start button. The engine should start immediately.

#### Piston stuck at "top dead center" (TDC)

"Top dead center" is the position where the piston is at the very top of the tapered sleeve. Occasionally an engine can get "stuck" at this position. This is most likely to happen on new engines during break-in, but can also happen at other times. If the engine is stuck at TDC, use the following procedure to release the piston from the sleeve:

1. Remove the glow plug using the included tool or 8mm (5/16") nut driver and verify that the piston is at the top of its stroke.
2. Use a flat blade screwdriver to rotate the flywheel. Place the blade of the driver into one of the grooves of the flywheel and push down, turning the flywheel counterclockwise when viewed from the front. The flywheel should turn, unsticking the piston from the sleeve.
3. Put two or three drops of light machine oil into the glow plug hole to lubricate the piston and sleeve. Do not use too much oil. It will hydro-lock the engine. Verify the starter will spin the engine with the glow plug out.
4. Rotate the flywheel so the piston is at bottom dead center and replace the glow plug with the gasket. Reconnect the blue glow plug wire.
5. You should now be able to start the engine with the EZ-Start.

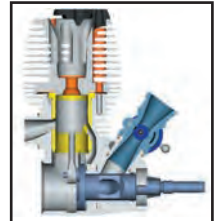

Top Dead Center

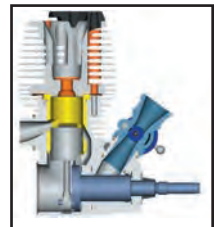
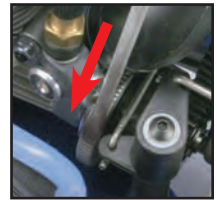

Bottom Dead Center

The following section addresses some very basic engine and radio questions you may have about your T-Maxx. Most questions arise from simple user errors or minor adjustments that are easy to correct. If you can't find a solution for your T-Maxx here, then visit our Web site at [www.Traxxas.com/support](http://www.Traxxas.com/support). There you will find a much more extensive and detailed online troubleshooting area. In addition, you may call Traxxas Customer Service at 1-888-TRAXXAS (outside the U.S., call +1-972-265-8000).

### **Radio system does not work properly:**

- If the power light on the transmitter does not come on, check for proper battery installation and that the batteries are new and/or fully charged. If the power light is blinking, then the transmitter batteries are weak and should be replaced. See page 10 for more details.
- If the transmitter light is on but the radio is still not responding, check for proper installation of the receiver batteries and that the batteries are new and/or fully charged. Check to make sure the on/off switch on the model is in the on position. Finally, if there is still no response, check the red and black wires that connect the battery pack to the "batt" terminal on the receiver (you will have to remove the receiver cover). Make sure the wires are not pinched or damaged and that the plug is secure in the receiver. See page 10 for more details.

### **Engine will not spin (EZ-Start will not turn the engine):**

- If neither LED on the controller lights, the EZ-Start battery could be discharged or improperly connected. Inspect and recharge if necessary.
- If the glow plug LED lights and the motor LED does not, then the EZ-Start controller is in protection mode. Allow the controller to cool for at least three minutes. The circuitry should automatically reset.
- Check to make sure the wires are connected to the EZ-Start motor in the T-Maxx. The red wire should connect to the positive motor terminal, indicated by a red dot next to the terminal.
- The engine could be flooded. If too much fuel accumulates in the combustion chamber at start up, the engine will hydraulically lock. Follow the procedure on page 34 for clearing a flooded engine.

- Check for binding at the engine flywheel. If you are not able to turn the engine by hand, the engine could be flooded, there could be binding in the clutch system, or there could be internal engine damage. (Note: It is normal for the engine to be extremely tight and hard to turn when the piston reaches the top of the compression stroke.)

### **Engine extremely sluggish, hard to start, and will not idle during tank 1 of the break in:**

- It is possible that the factory adjusted break-in settings on your carburetor are too rich for your geographic location, atmospheric conditions, or fuel brand. Extremes in temperature, humidity, barometric pressure, and altitude can't always be accounted for with a single high-speed needle setting. The symptoms described above can occur when the air density is very low, such as in high mountainous elevations and extremely cold temperatures. Under these conditions, lean the fuel mixture slightly, 1/8 turn, to see if there is any improvement in starting and idling. Only lean the fuel mixture just until the engine will run and idle reliably and then proceed with the break in.
- The contents of different brands of fuel (other than Traxxas Top Fuel) in combination with extreme atmospheric conditions can also make the factory preset break-in settings too rich and cause the symptoms described above. Again, try leaning the fuel mixture slightly, 1/8 turn, to see if there is any improvement in starting and idling.

### **Engine spins but will not start:**

- If the engine is spinning but will not start, first check to make sure that both the motor and glow plug LEDs on the EZ-Start controller light when the button is depressed. If the glow plug LED does not light, make sure the blue glow plug wire is tightly connected and is not damaged in any way. If the wire is good, then replace the glow plug. It is normal for glow plugs to require periodic replacement. Only use Traxxas heavy-duty long glow plugs (see your parts list).
- Check your fuel mixture settings. It may be necessary to adjust the fuel mixture if the outside temperature or barometric pressure has changed significantly since the last time the engine was run (see Fine Tuning the Carburetor on 28). Turn the high-speed needle out (rich/counterclockwise) 1/4 turn, hold the throttle trigger at about 1/2 throttle and try again to start the engine. Once started, retune the engine for performance (see page 26).

- Check to make sure the fuel is getting to the carburetor. Remove the fuel line where it connects to the carburetor to see if there is fuel in it. If not, you may need to prime the engine. Reconnect the fuel line and then refer to page 24 for instructions on priming the engine.
- The engine could be worn. If the fit between the piston and sleeve is loose, compression is reduced, and the engine will be difficult to start when it is warm and may tend to stall when running and when the throttle is closed suddenly to idle. Engine life depends on many factors, including fuel type, air filter maintenance, needle settings, and how the engine was used. For example, if the engine was allowed to ingest dirt from lack of air filter maintenance or running through water, then the internal engine components could wear out extremely fast.
- Glow plug may have failed. If using an EZ-Start, check to see if the glow plug light is on during starting. If not, replace the glow plug. If using a glow ignitor, remove and check the glow plug.

### **Engine performance sluggish:**

- Engine performance depends mostly on the fuel mixture settings and how they compensate for the current atmospheric conditions. Before you suspect other failures with the engine, richen the high-speed needle at least 1/4 turn and then retune the engine for performance (see page 26).
- If the fuel mixture seems to be set correctly, make sure the fuel is fresh. If the fuel is old or was left uncapped for a long period, then some of the important fuel components could have evaporated. Try new, fresh Traxxas Top Fuel.
- Try a new Traxxas glow plug. Sometimes a glow plug will work well enough to start the engine, but will not be able to deliver the engine's full performance potential.
- Check to make sure there is no binding in the driveline that would cause excessive loads on the engine.



# T-MAXX

OWNER'S MANUAL

MODEL 49104-1

**TRAXXAS**

6250 TRAXXAS WAY, MCKINNEY, TX 75070

1-888-TRAXXAS